

# ROUGH COUNTRY

SUSPENSION SYSTEMS®



109INSTBAG1

27.11  
(688.7 mm)

## CHEVY 2021 Tahoe/Suburban 6" Lift Kit

Thank you for choosing Rough Country for your suspension needs.

Rough Country recommends a certified technician install this system. In addition to these instructions, professional knowledge of disassemble/reassembly procedures as well as post installation checks must be known. Attempts to install this system without this knowledge and expertise may jeopardize the integrity and/or operating safety of the vehicle.

Please read instructions before beginning installation. Check the kit hardware. Be sure you have all needed parts and know where they go.

### PRODUCT USE INFORMATION

**▲WARNING** As a general rule, the taller a vehicle is, the easier it will roll. Seat belts and shoulder harnesses should be worn at all times. Avoid situations where a side rollover may occur. Generally, braking performance and capability are decreased when larger/heavier tires and wheels are used. Take this into consideration while driving. Do not add, alter, or fabricate any factory or after-market parts to increase vehicle height over the intended height of the Rough Country product purchased. Mixing component brands is not recommended.

Rough Country makes no claims regarding lifting devices and excludes any and all implied claims. We will not be responsible for any product that is altered. We will be happy to answer any questions concerning the design, function, and correct use of our products.

This kit is packaged as a leveling kit—raising the front 6" and the rear 5".

Due to differences in manufacturing, dimension and inflated measurements, tire and wheel combinations should be test fit prior to installation.

This suspension system was developed using a 35" x 12.5" tire with 20" x 9" wheel and a offset of -12mm or -6mm offset with a 1/4" wheel spacer. 20x10 wheels require -24mm offset or -18mm offset with a 1/4" wheel spacer. **Max backspacing of 4.5"**. If wider tires are used trimming may be required.

### ▲NOTICE NOTICE TO DEALER AND VEHICLE OWNER

Any vehicle equipped with any Rough Country product should have a "Warning to Driver" decal installed on the inside of the windshield or on the vehicle's dash. The decal should act as a constant reminder for whoever is operating the vehicle of its unique handling characteristics.

INSTALLING DEALER - it is your responsibility to install the warning decal and forward these installation instructions on to the vehicle owner for review. These instructions should be kept in the vehicle for its service life.

#### Tools Needed:

T10 Torx Bit	9/16" socket/wrench
T30 Torx Bit	5/8" socket/wrench
8mm Allen Socket	11/16" socket/wrench
10mm socket/wrench	3/4" socket/wrench
11mm socket/wrench	13/16" socket/wrench
13mm socket/wrench	15/16" socket/wrench
15mm socket/ wrench	1 1/16" socket/wrench
17mm socket/wrench	Floor Jack /Jack Stands
18mm socket/wrench	Torsion bar Tool
19mm socket/wrench	Reciprocating Saw
21mm socket/wrench	Drill
22mm socket/wrench	11/16" Drill Bit
24mm socket/wrench	Hand Grinder
36mm socket	Thread Locker

#### Torque Specs:

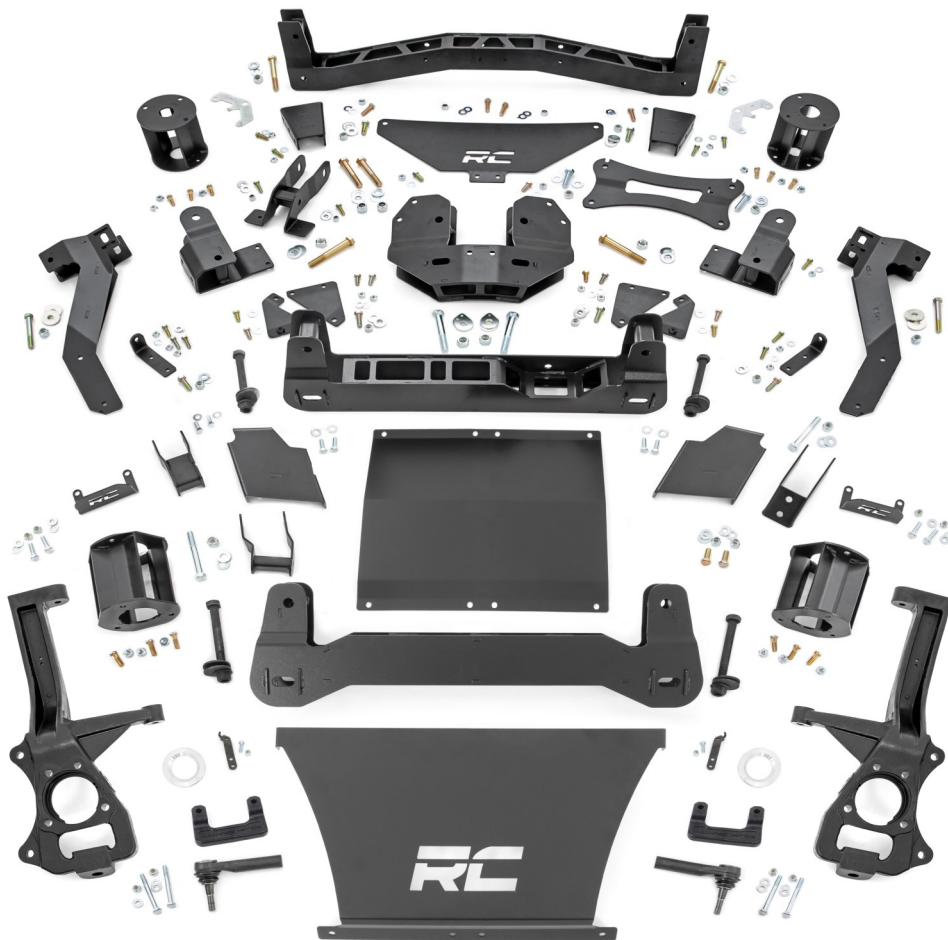
Size	Grade 5	Grade 8
5/16"	15 ft/lbs	20 ft/lbs
3/8"	30 ft/lbs	35 ft/lbs
7/16"	45 ft/lbs	60 ft/lbs
1/2"	65 ft/lbs	90 ft/lbs
9/16"	95 ft/lbs	130 ft/lbs
5/8"	135 ft/lbs	175 ft/lbs
3/4"	185 ft/lbs	280 ft/lbs
	Class 8.8	Class 10.9
6MM	5 ft/lbs	9 ft/lbs
8MM	18ft/lbs	23 ft/lbs
10MM	32ft/lbs	45ft/lbs
12MM	55ft/lbs	75ft/lbs
14MM	85ft/lbs	120ft/lbs
16MM	130ft/lbs	165ft/lbs
18MM	170ft/lbs	240ft/lbs



11100 (Tahoe) Kit Pic



10900 (Suburban) Kit Pic



## 11100 (Tahoe) Kit Components

### 10900BOX1 (Front)

- 1 - 1253BAG2
  - 8 - 3/4" Flat Washers
  - 2 - 18MM-2.5x120MM Bolts
  - 2 - 18MM-2.5x140MM Bolts
  - 4 - 18MM-2.5 Lock Nuts
- 1 - 217BAG2
  - 2 - 3/8"-16x3.75" Bolts
  - 8 - 3/8"-16x1" Bolts
  - 2 - 3/8"-16 Lock Nuts
  - 20 - 3/8" Flat Washers
  - 8 - 3/8" Lock Washer
  - 4 - 10MM-1.5x35MM Bolts
  - 4 - 10MM-1.5 Lock Nuts
  - 1 - 3/16"x4.5" Vent Hose
  - 1 - 3/16" Vent Tube Coupler
  - 2 - 1/2"-13x1.25 Bolts
  - 2 - 1/2"-13 Lock Nuts
  - 1 - 14MM-2x100MM Bolt
  - 1 - 14MM-2x110MM Bolt
  - 2 - 14MM-2 Lock Nut
- 1 - 217BAG6
  - 1 - Dr Front Brake Line Bracket
  - 1 - Pass Front Brake Line Bracket
  - 2 - 1/4"-20x3/4" Bolts
  - 2 - 1/4"-20 Lock Nuts
- 1 - 109INSTRBAG
  - 1 - Instructions
- 1 - Full Lower Skid Plate
- 1 - Driver Diff Drop Bracket
- 1 - Pass Diff Drop Bracket
- 1 - Rear Diff Mount
- 1 - Driver Sway Bar Drop
- 1 - Pass Sway Bar Drop
- 1 - Cam bolts (Bag of 4)
- 2 - CV Spacers
- 2 - Tie Rod Ends

### 11100BOX2 (Front Strut Spacers)

- 1 - Driver Side Upper Strut Spacer
- 1 - Pass Side Upper Strut Spacer
- 1 - 10MMSTUDBAG-2019
  - 1 - 1/2" Jam Nut
  - 1 - 10MM-1.25 Hex Nut
  - 6 - 10MM-1.25x40MM Studs
  - 6 - 10MM-1.25 Flange Nuts
- 1 - 1318BAG
  - 4 - Lower Strut Spacers
  - 4 - 10MM-1.5X80MM Bolts
  - 4 - 10MM-1.5 Lock Nuts
  - 8 - 10MM Flat Washers
- 2 - RC Strut Covers

### 217BOX3

- 1 - RC Front Skid Plate

### 217BOX11

- 1 - Front Crossmember
- 1 - Rear Crossmember

### 21730BOX5

- 1 - Dr Knuckle Box

### 21730BOX6

- 1 - Pass Knuckle Box

### 10900BOX3 (Rear - Driver Side)

- 1 - 10900BAG4 (Toe Arm Drop)
  - 2 - 9/16"-12X4" Bolts
  - 4 - Tie Rod Drop Washers
  - 2 - 9/16"-12 Lock Nuts
  - 4 - 7/16"-14x1.5" Bolts
  - 4 - 7/16"-14 Lock Nuts
  - 8 - 7/16" Flat Washers
  - 4 - 3/8"-16x1.25" Bolts
  - 4 - 3/8"-16 Flange Nuts
  - 4 - 3/8" Flat Washers
- 1 - Diff Bracket (Front of Diff)
- 1 - Diff Bracket (Rear of Diff)
- 1 - Lower Control Arm Drop Bracket
- 1 - Dr Lwr Control Arm Drop (Fr Brace)
- 1 - Dr Lwr Control Arm Drop (Rr Brace)
- 1 - Dr Tie Rod Drop Bracket
- 1 - Dr Trailing Arm Drop Bracket
- 1 - Dr ABS Bracket
- 2 - Sway Bar Drop Brackets

### 10900BOX4 (Rear - Pass Side)

- 1 - 10900BAG1 (Diff Drop)
  - 2 - 5/8"-11x4" Bolts
  - 2 - 5/8"-11 Lock Nuts
  - 4 - 5/8" Flat Washers
  - 2 - 3/8"-16x1.25" Bolts
  - 2 - 3/8"-16" Lock Nuts
  - 4 - 3/8" Flat Washers
  - 2 - 14MM-2x50MM
  - 2 - 14MM-2 Lock Nuts
  - 4 - 14MM Flat Washer
- 1 - 10900BAG2 (Control Arm Drop)
  - 2 - 9/16"-12x4" Bolts
  - 2 - 9/16"-12 Lock Nuts
  - 4 - 9/16" Flat Washers
  - 2 - 18MM-2.5x120MM Bolts
  - 2 - 18MM-2 Lock Nuts
  - 4 - Lwr Ctrl Arm Drop Block Offs
  - 8 - 7/16"-14x1 Bolts
  - 4 - 7/16"-14 Lock Nuts
  - 8 - 7/16" Flat Washers
  - 4 - 1/2"-13x1.5" Bolts
  - 4 - 1/2"-13 Lock Nuts
  - 8 - Thick 1/2 Flat Washers
- 1 - 10900BAG3 (Trailing Arm Drop)
  - 2 - 5/8"-11x4.5 Bolts
  - 2 - 5/8"-11 Lock Nuts
  - 4 - 5/8" Flat Washers
  - 6 - 3/8"-16x1.25" Bolts
  - 6 - 3/8"-16 Flange Nuts
  - 6 - 3/8" Flat Washers
  - 2 - 1/2"-13x1.5 Bolts
  - 2 - 1/2"-13 Lock Nuts
  - 4 - 1/2" Flat Washers
  - 2 - 7/16"-14x1" Bolts
  - 2 - 7/16"-14 Lock Nuts
  - 2 - 7/16" Flat Washers
- 1 - Pass Lwr Ctrl Arm Drop (Fr Brace)
- 1 - Pass Lwr Ctrl Arm Drop (Rr Brace)
- 1 - Pass Tie Rod Drop Bracket
- 1 - Pass Trailing Arm Drop Bracket
- 1 - Pass ABS Bracket
- 2 - 6" Spacers
- 2 - Trailing Arm Braces
- 1 - 10MMSTUDBAG-2
  - 1 - 1/2" Jam Nut
  - 1 - 10MM-1.25 Hex Nut
  - 6 - 10MM-1.25 Studs
  - 6 - 10MM-1.25 Flange Nuts
- 1 - RC Rear Pocket Cover
- 1 - Upper Control Arm Drop Bracket



## 10900 (Suburban) Kit Components

### 10900BOX1 (Front)

- 1 - 1253BAG2
  - 8 - 3/4" Flat Washers
  - 2 - 18MM-2.5x120MM Bolts
  - 2 - 18MM-2.5x140MM Bolts
  - 4 - 18MM-2.5 Lock Nuts
- 1 - 217BAG2
  - 2 - 3/8"-16x3.75" Bolts
  - 8 - 3/8"-16x1" Bolts
  - 2 - 3/8"-16 Lock Nuts
  - 20 - 3/8" Flat Washers
  - 8 - 3/8" Lock Washer
  - 4 - 10MM-1.5x35MM Bolts
  - 4 - 10MM-1.5 Lock Nuts
  - 1 - 3/16"x4.5" Vent Hose
  - 1 - 3/16" Vent Tube Coupler
  - 2 - 1/2"-13x1.25 Bolts
  - 2 - 1/2"-13 Lock Nuts
  - 1 - 14MM-2x100MM Bolt
  - 1 - 14MM-2x110MM Bolt
  - 2 - 14MM-2 Lock Nut
- 1 - 217BAG6
  - 1 - Dr Front Brake Line Bracket
  - 1 - Pass Front Brake Line Bracket
  - 2 - 1/4"-20x3/4" Bolts
  - 2 - 1/4"-20 Lock Nuts
- 1 - 109INSTRBAG
  - 1 - Instructions
- 1 - Full Lower Skid Plate
- 1 - Driver Diff Drop Bracket
- 1 - Pass Diff Drop Bracket
- 1 - Rear Diff Mount
- 1 - Driver Sway Bar Drop
- 1 - Pass Sway Bar Drop
- 1 - Cam bolts (Bag of 4)
- 2 - CV Spacers
- 2 - Tie Rod Ends

### 10900BOX2 (Front Strut Spacers)

- 1 - Driver Side Upper Strut Spacer
- 1 - Pass Side Upper Strut Spacer
- 1 - 10MMSTUDBAG-2019
  - 1 - 1/2" Jam Nut
  - 1 - 10MM-1.25 Hex Nut
  - 6 - 10MM-1.25x40MM Studs
  - 6 - 10MM-1.25 Flange Nuts
- 1 - 1307BAG1
  - 4 - 10MM-1.5x85MM Bolts
  - 4 - 10MM-1.5 Lock Nuts
  - 8 - 3/8" Flat Washers
- 1 - Instructions
- 2 - 2" Lower Strut Spacers
- 2 - RC Strut Covers

### 217BOX3

- 1 - RC Front Skid Plate

### 217BOX11

- 1 - Front Crossmember
- 1 - Rear Crossmember

### 21730BOX5

- 1 - Dr Knuckle Box

### 21730BOX6

- 1 - Pass Knuckle Box

### 10900BOX3 (Rear - Driver Side)

- 1 - 10900BAG4 (Toe Arm Drop)
  - 2 - 9/16"-12X4" Bolts
  - 4 - Tie Rod Drop Washers
  - 2 - 9/16"-12 Lock Nuts
  - 4 - 7/16"-14x1.5" Bolts
  - 4 - 7/16"-14 Lock Nuts
  - 8 - 7/16" Flat Washers
  - 4 - 3/8"-16x1.25" Bolts
  - 4 - 3/8"-16 Flange Nuts
  - 4 - 3/8" Flat Washers
- 1 - Diff Bracket (Front of Diff)
- 1 - Diff Bracket (Rear of Diff)
- 1 - Lower Control Arm Drop Bracket
- 1 - Dr Lwr Control Arm Drop (Fr Brace)
- 1 - Dr Lwr Control Arm Drop (Rr Brace)
- 1 - Dr Tie Rod Drop Bracket
- 1 - Dr Trailing Arm Drop Bracket
- 1 - Dr ABS Bracket
- 2 - Sway Bar Drop Brackets

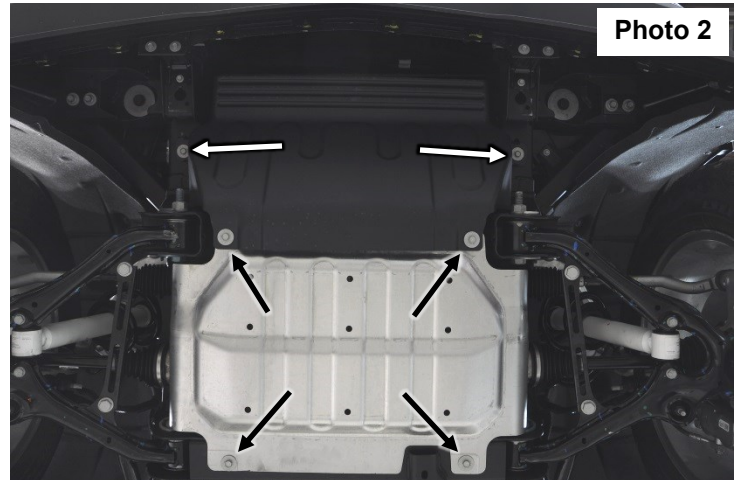
### 10900BOX4 (Rear - Pass Side)

- 1 - 10900BAG1 (Diff Drop)
  - 2 - 5/8"-11x4" Bolts
  - 2 - 5/8"-11 Lock Nuts
  - 4 - 5/8" Flat Washers
  - 2 - 3/8"-16x1.25" Bolts
  - 2 - 3/8"-16" Lock Nuts
  - 4 - 3/8" Flat Washers
  - 2 - 14MM-2x50MM
  - 2 - 14MM-2 Lock Nuts
  - 4 - 14MM Flat Washer
- 1 - 10900BAG2 (Control Arm Drop)
  - 2 - 9/16"-12x4" Bolts
  - 2 - 9/16"-12 Lock Nuts
  - 4 - 9/16" Flat Washers
  - 2 - 18MM-2.5x120MM Bolts
  - 2 - 18MM-2 Lock Nuts
  - 4 - Lwr Ctrl Arm Drop Block Offs
  - 8 - 7/16"-14x1 Bolts
  - 4 - 7/16"-14 Lock Nuts
  - 8 - 7/16" Flat Washers
  - 4 - 1/2"-13x1.5" Bolts
  - 4 - 1/2"-13 Lock Nuts
  - 8 - Thick 1/2 Flat Washers
- 1 - 10900BAG3 (Trailing Arm Drop)
  - 2 - 5/8"-11x4.5 Bolts
  - 2 - 5/8"-11 Lock Nuts
  - 4 - 5/8" Flat Washers
  - 6 - 3/8"-16x1.25" Bolts
  - 6 - 3/8"-16 Flange Nuts
  - 6 - 3/8" Flat Washers
  - 2 - 1/2"-13x1.5 Bolts
  - 2 - 1/2"-13 Lock Nuts
  - 4 - 1/2" Flat Washers
  - 2 - 7/16"-14x1" Bolts
  - 2 - 7/16"-14 Lock Nuts
  - 2 - 7/16" Flat Washers
- 1 - Pass Lwr Ctrl Arm Drop (Fr Brace)
- 1 - Pass Lwr Ctrl Arm Drop (Rr Brace)
- 1 - Pass Tie Rod Drop Bracket
- 1 - Pass Trailing Arm Drop Bracket
- 1 - Pass ABS Bracket
- 2 - 6" Spacers
- 2 - Trailing Arm Braces
- 1 - 10MMSTUDBAG-2
  - 1 - 1/2" Jam Nut
  - 1 - 10MM-1.25 Hex Nut
  - 6 - 10MM-1.25 Studs
  - 6 - 10MM-1.25 Flange Nuts
- 1 - RC Rear Pocket Cover
- 1 - Upper Control Arm Drop Bracket

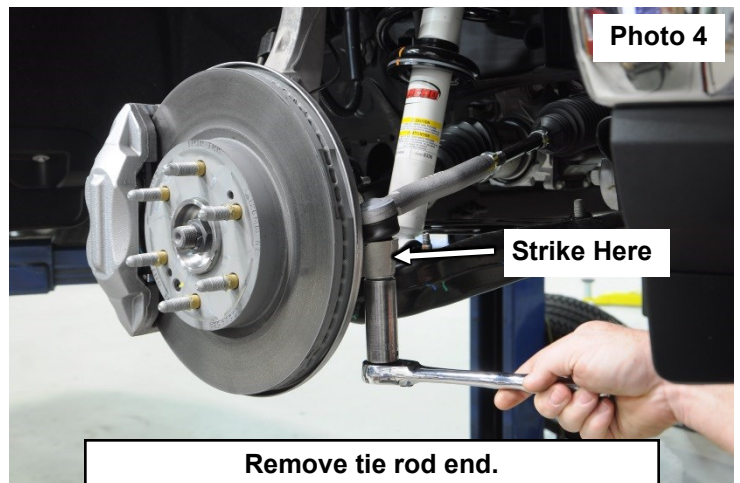
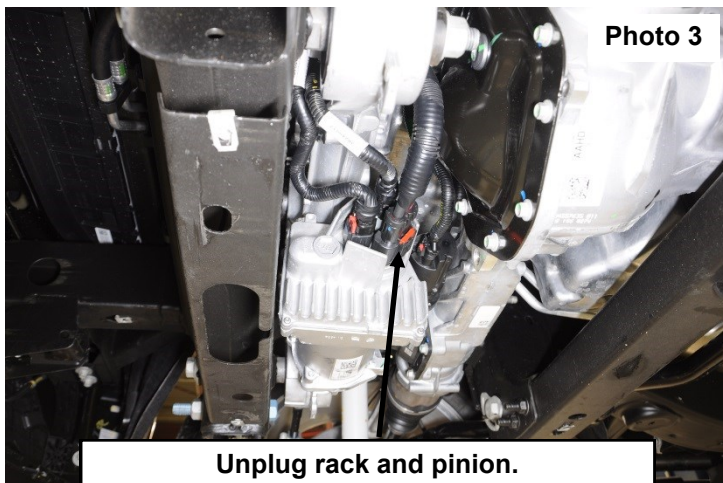


## FRONT INSTALLATION

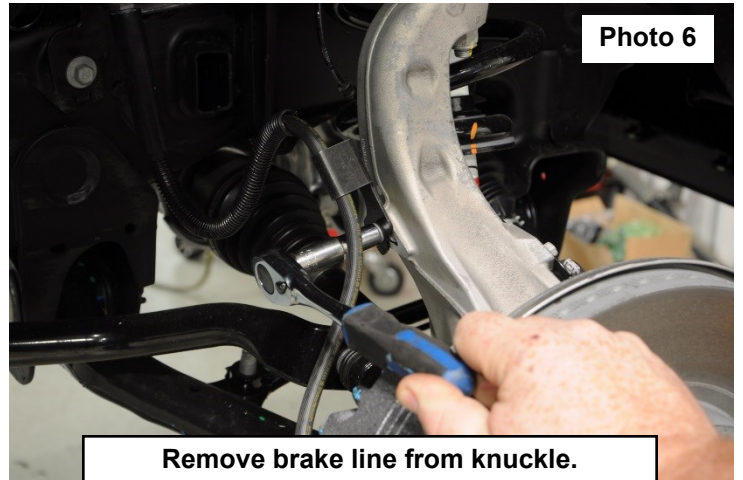
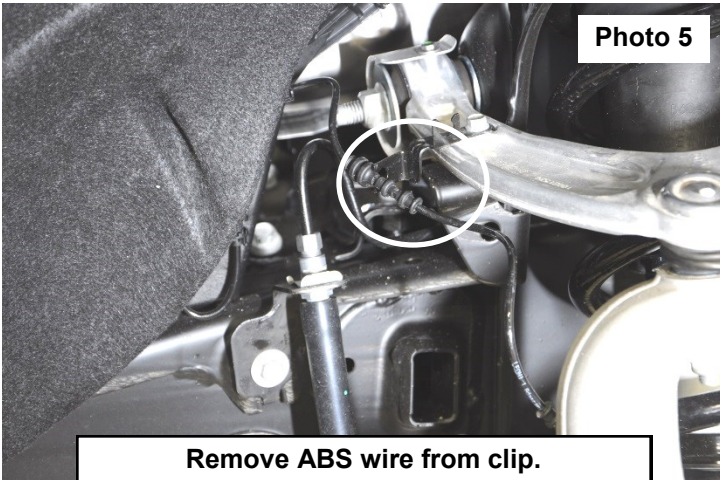
1. Park the vehicle on a level surface and chock the rear wheels. Lock the steering wheel in the straight position.
2. Jack up the front of the vehicle. Place jack stands under the frame rails and lower onto jack stands letting the front suspension hang.
3. Raise the hood and disconnect the battery using a 10mm socket.
4. Remove the tires and wheels.
5. Remove the 6 bolts holding the factory skid plates, using a 13mm socket. **See Photos 1 & 2.**



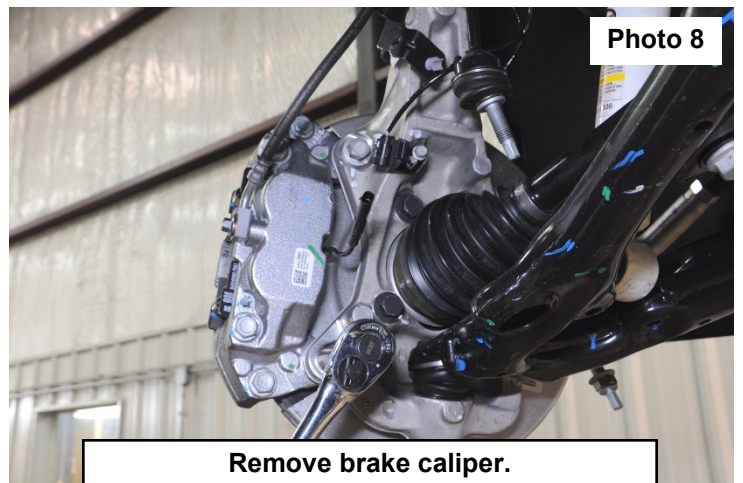
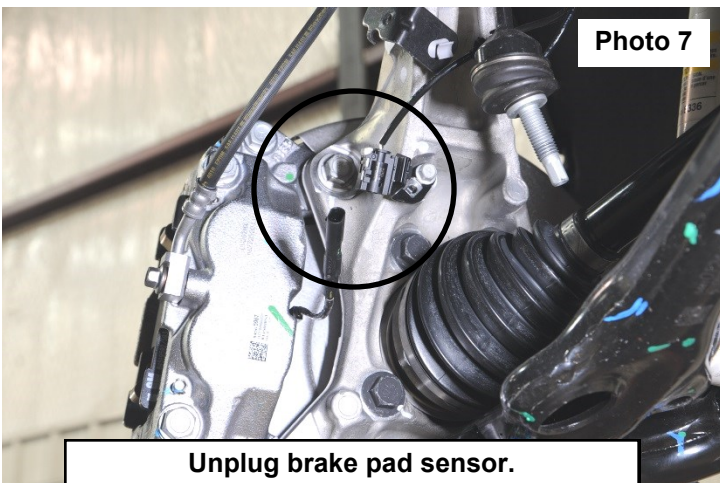
6. Unplug the three connectors going to the rack and pinion. **See Photo 3.**
7. Using a 21mm socket, remove the tie-rod nut as shown in **Photo 4**. Using a hammer, strike the front of the mount to dislodge the tie rod end. Remove from the knuckle.



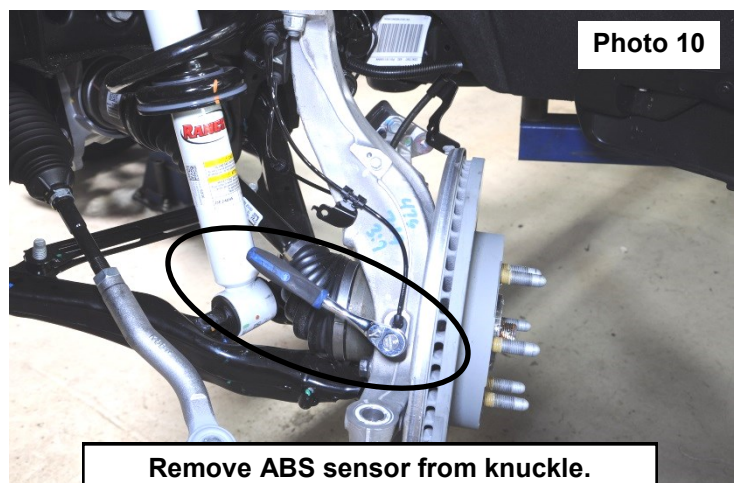
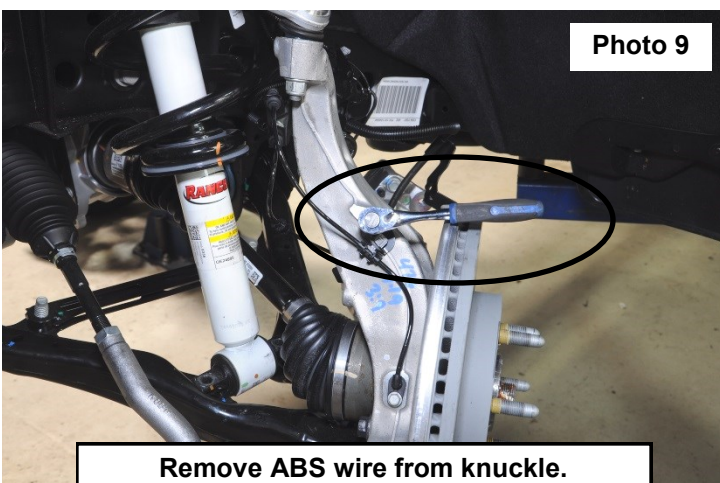
8. Remove the ABS wire from the clip on the upper control arm mount. **See Photo 5.**
9. Using a 10mm socket, remove the brake line and brake pad sensor wires from the knuckle. Retain hardware. **See Photo 6.**



10. Unplug the brake pad sensor wire. **See Photo 7.**
11. Using an 18mm socket, remove the brake caliper. Hang caliper out of the way. **Do not hang the caliper by the brake line.** Retain hardware. **See Photo 8.**

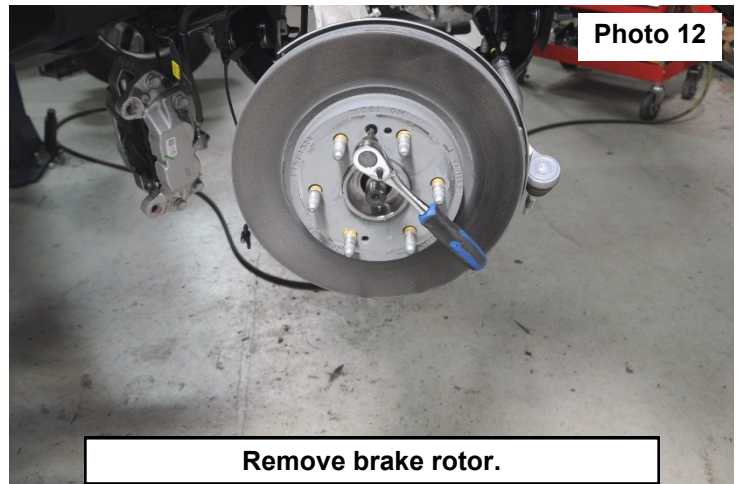
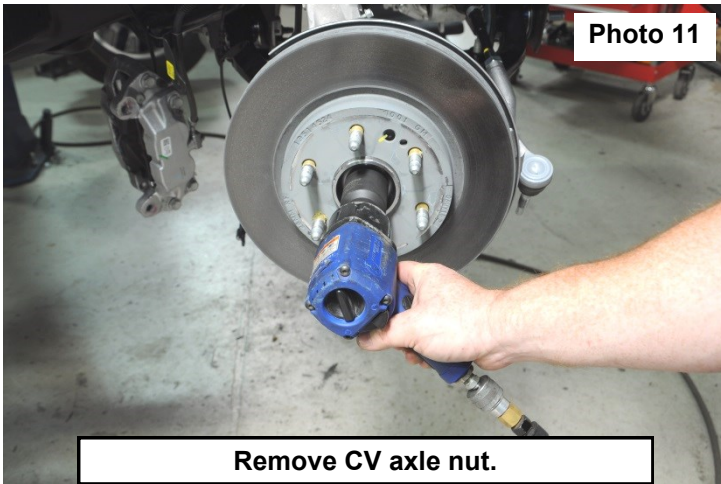


12. Using a 10mm socket, remove the ABS wire bracket from the knuckle. Retain hardware. **See Photo 9.**
13. Using a 10mm socket, remove the ABS sensor from the knuckle. Retain hardware and hang ABS wire out of the way. **See Photo 10.**



14. Remove the CV axle nut using a 36mm socket. Retain hardware. **See Photo 11.**

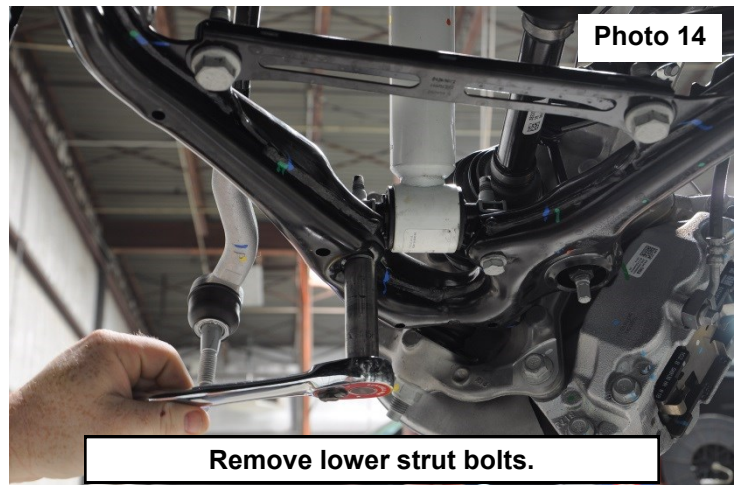
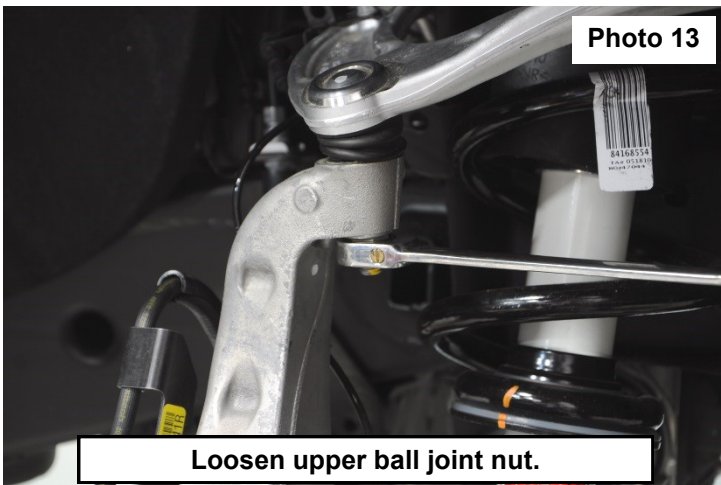
15. Using a 30T torx, remove the brake rotor. Retain hardware. **See Photo 12.**



16. Using an 18mm wrench, loosen the upper ball joint nut. Do not completely remove the nut. Strike the knuckle with a hammer to release the ball joint taper. **See Photo 13.**

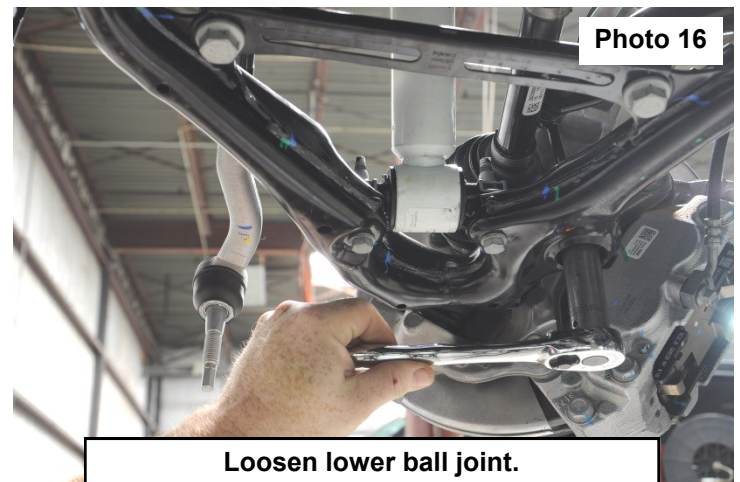
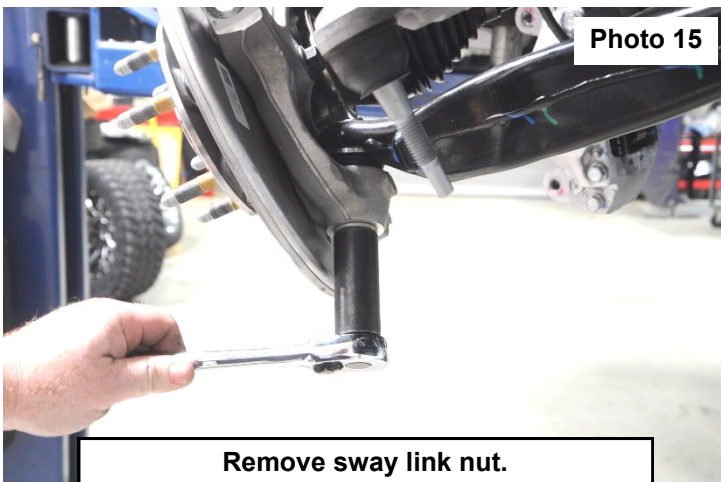
17. Support the lower control arm.

18. Using a 15mm socket, remove the lower strut mounting bolts. **See Photo 14.**

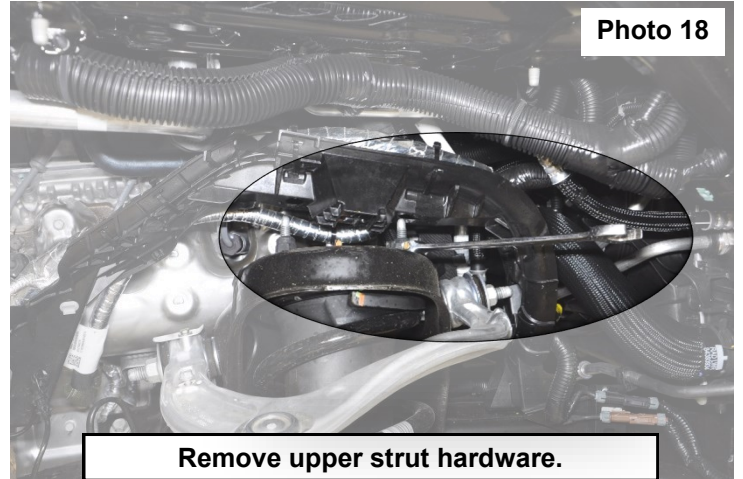
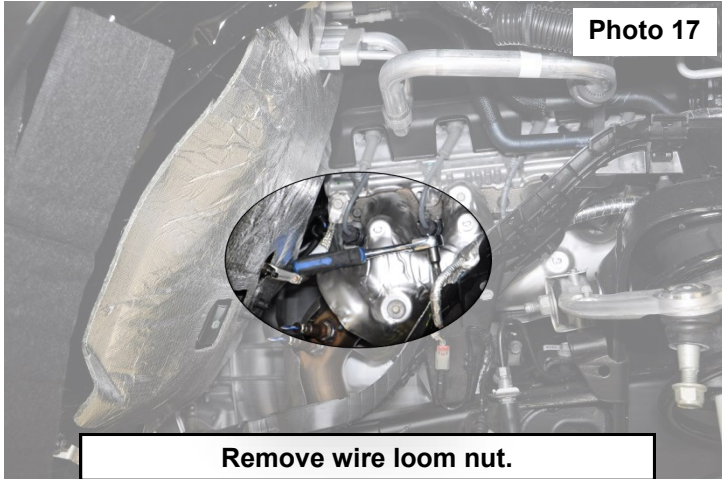


19. Using a 24mm socket, loosen the lower ball joint nut. Do not completely remove the nut. Strike the knuckle with a hammer to release the ball joint taper, remove the upper and lower ball joint nuts and remove the knuckle from the truck. Retain hardware. **See Photo 15.**

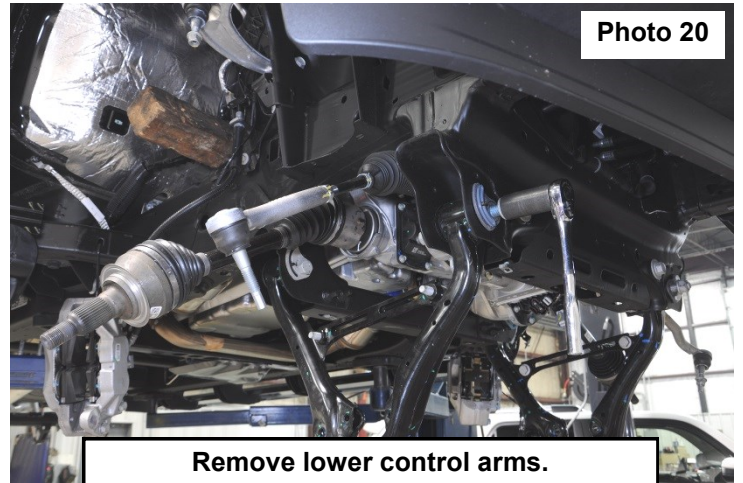
20. Remove the lower sway link nut using an 18mm socket. Retain hardware. **See Photo 16.**



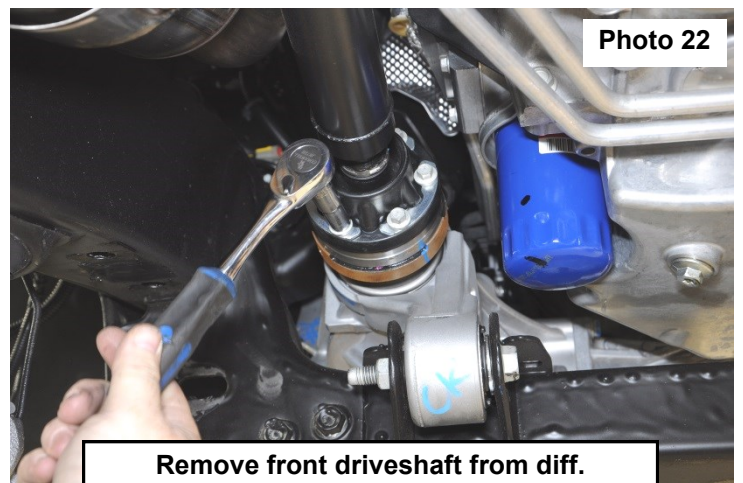
21. On the passenger side, use a 13mm socket to remove the bolt holding the plastic wire loom that is attached to the frame and the upper strut tower. Retain hardware. (Inner fender was removed for pictures) **See Photo 17.**
22. Using an 18mm wrench, remove the upper strut nuts. Retain hardware. **See Photo 18.**



23. Using a 10mm socket, remove the sway bar from the frame. Retain hardware. **See Photo 19.**
24. Using a 27mm socket, remove the lower control arms. Retain hardware. **See Photo 20.**

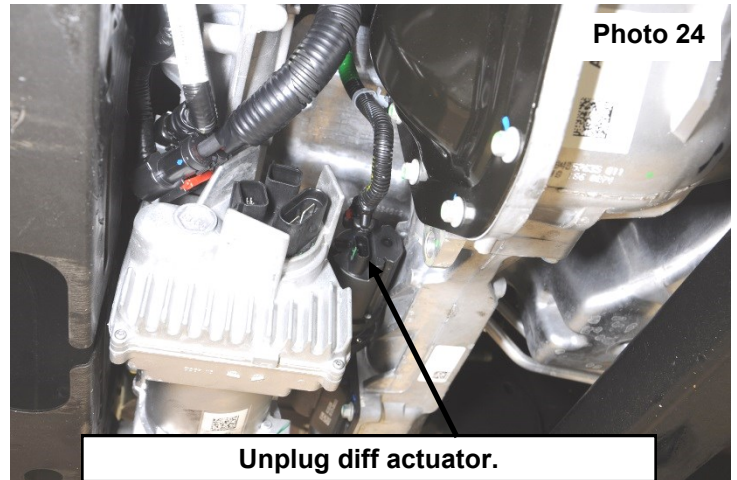
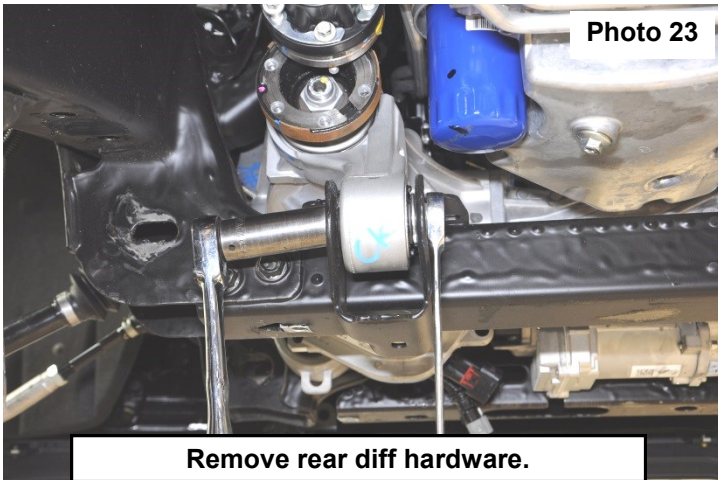


25. Mark the front driveshaft and the front yoke. **See Photo 21.**
26. Remove the front driveshaft using a 10mm socket. Retain hardware. Do not allow driveshaft to hang from the rear joint, this could damage the boot. Support the driveshaft with a jack stand. **See Photo 22.**

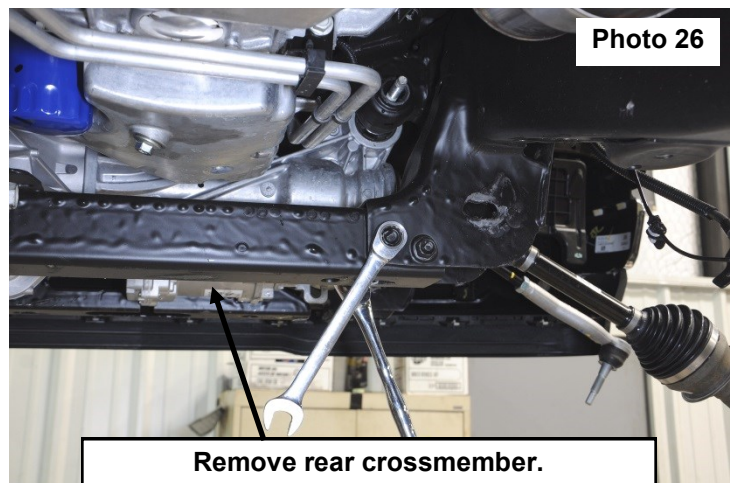
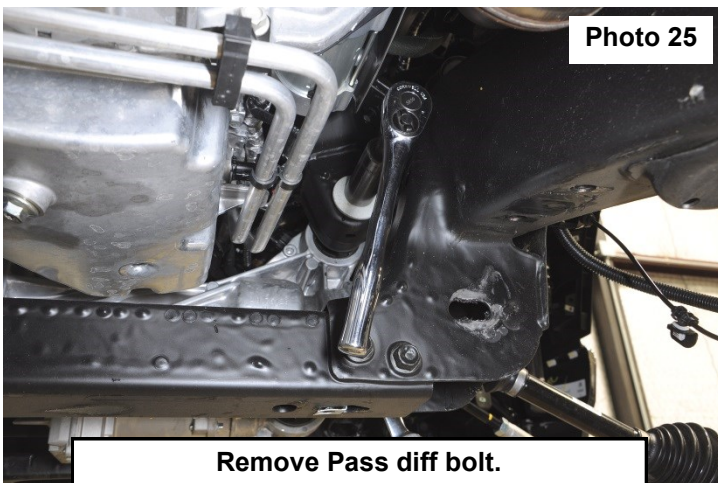




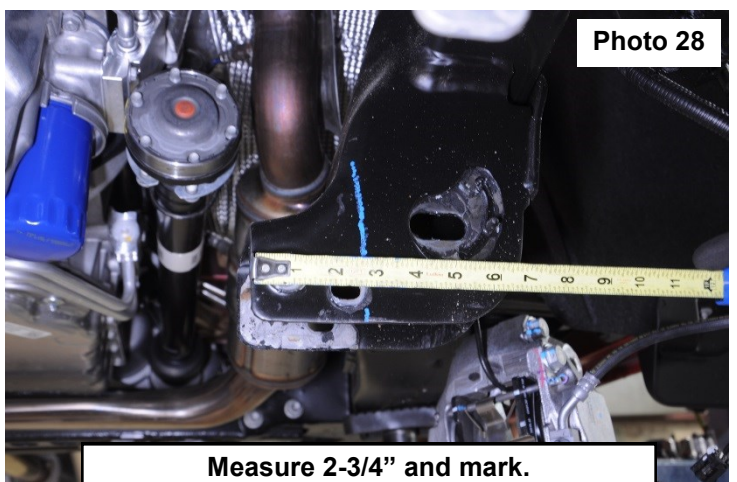
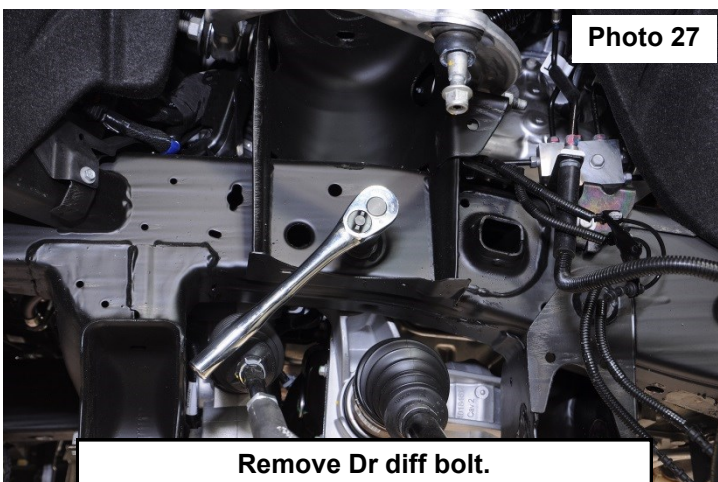
27. Using a 21mm wrench and socket, remove the rear diff bolt from the crossmember. Retain hardware. **See Photo 23.**  
 28. Unplug the diff actuator and remove the wire loom clips from the diff and vent hose. **See Photo 24.**



29. Support the differential using a jack.  
 30. Using a 21mm socket and wrench, remove the nut from the passenger side diff bolt. Retain hardware. **See Photo 25.**  
 31. Remove the rear crossmember using an 18mm wrench and socket. **See Photo 26.**



32. Using a 21mm socket and 22mm wrench, remove the driver and passenger diff bolts. To remove the pass side bolt, you will need to push the diff to the pass side and roll the back of the diff upward. Lower the differential. Retain hardware. **See Photo 27.**  
 33. On the rear driver side crossmember mount, measure 2-3/4" and mark. **See Photo 28.**



34. Cut along the mark made in step 33 using a reciprocating saw. Sand and paint the cut edge to prevent rust. **See Photo to 29.**
35. Install the supplied driver side diff drop bracket using the factory bolt. Do not tighten at this time. **See Photo 30.**

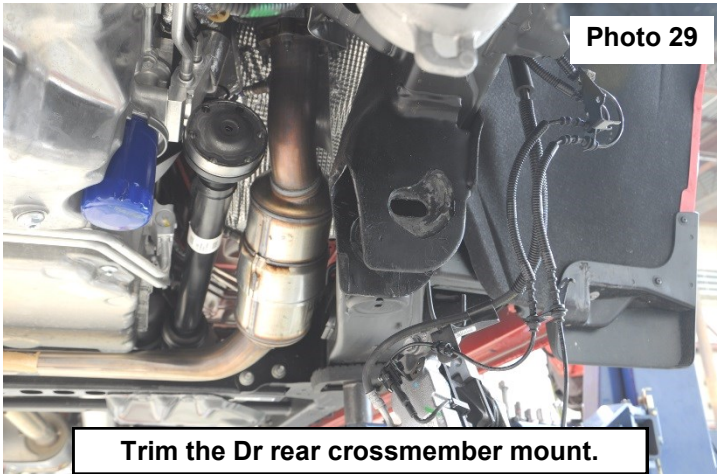


Photo 29

Trim the Dr rear crossmember mount.

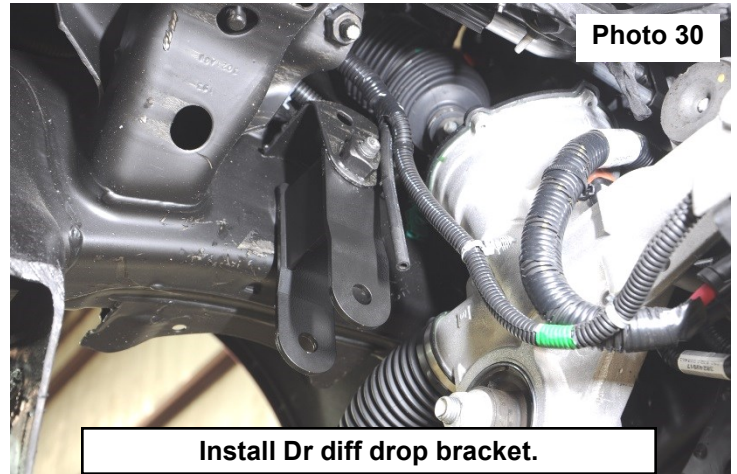


Photo 30

Install Dr diff drop bracket.

36. Install the supplied passenger side diff drop using the supplied 14mm x 110mm bolt, washers, and nylock nut. Do not tighten at this time. **See Photo 31.**
37. Install the diff using the factory hardware on the pass side and the supplied 14mm x 100m bolt, washers, and nylock nut on the driver side. Do not tighten at this time. **See Photos 32 & 33.**

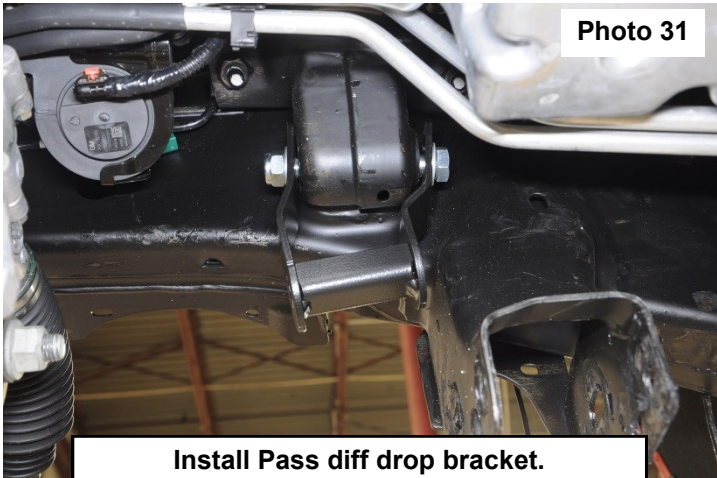


Photo 31

Install Pass diff drop bracket.

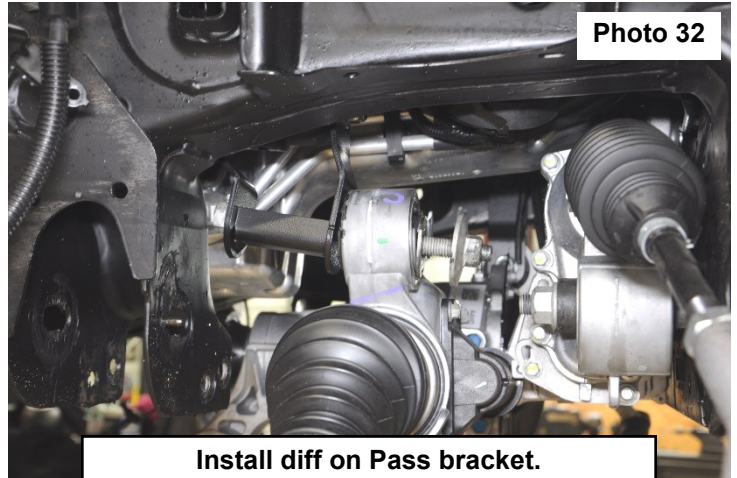


Photo 32

Install diff on Pass bracket.

38. Cut the supplied 3/16" vent tube in half, install the supplied 3/16" vent tube coupler and one half of the 3/16" vent tube on the diff and in the factory vent tube. **See Photo 34.**

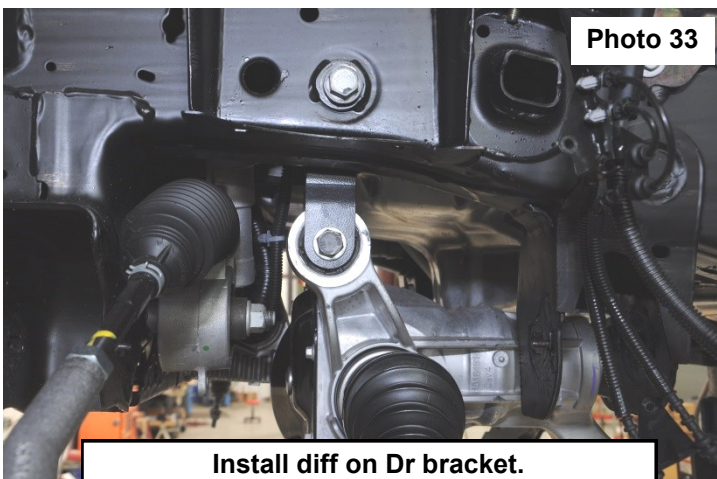


Photo 33

Install diff on Dr bracket.

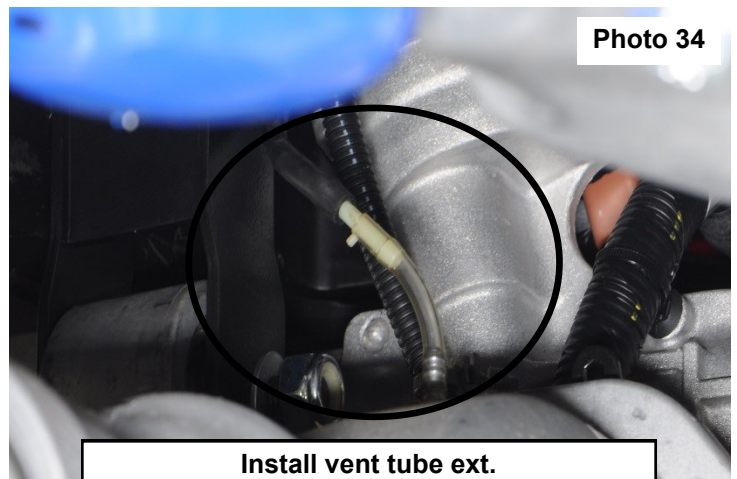
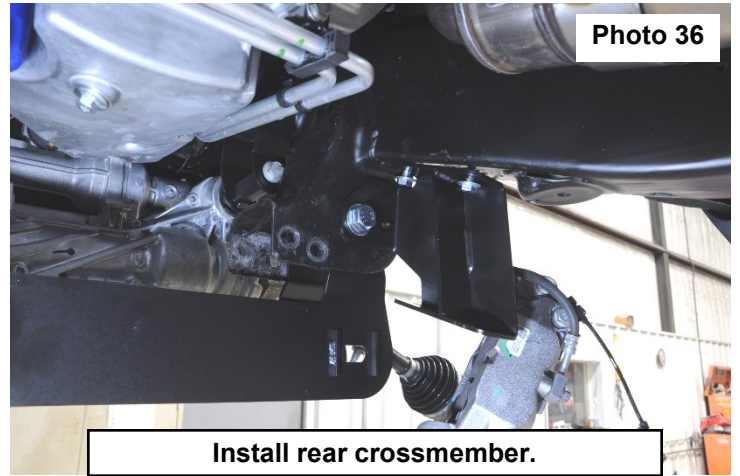


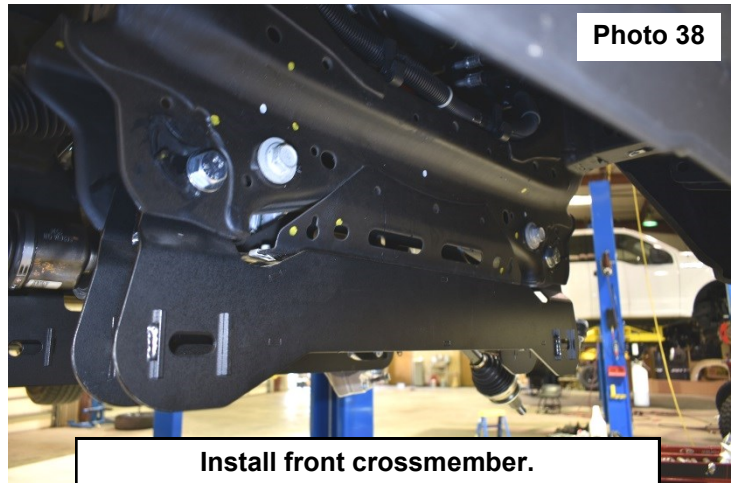
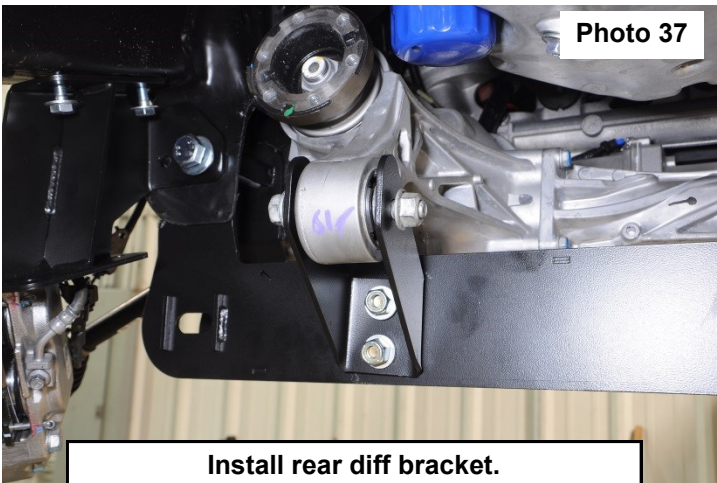
Photo 34

Install vent tube ext.

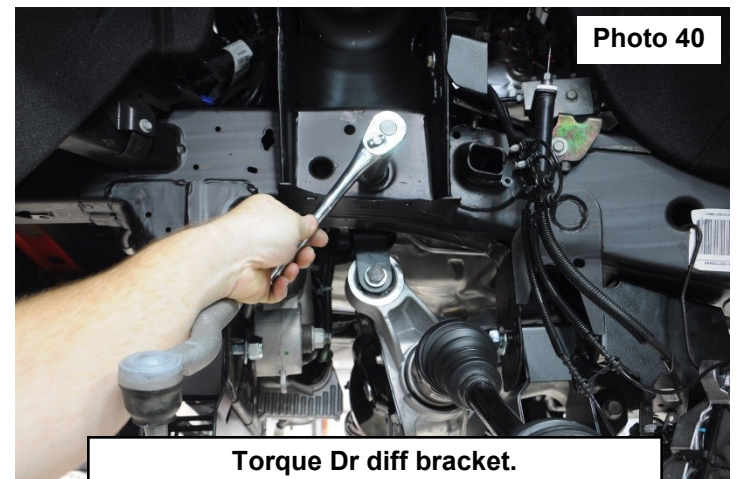
39. Install the supplied sway bar drops using the factory hardware. Do not tighten at this time. **See Photo 35.**
40. Install the supplied rear crossmember using the supplied 18mm x 140mm bolts, washers, and 18mm nylock nuts. The bolts will go through the sway bar drop brackets. Do not tighten. **See Photo 36.**



41. Install the supplied rear diff mount onto the rear crossmember using the supplied 1/2" x 1.25" bolts, flat washers, and nylock nuts. Install the factory hardware through the diff and diff mount. Do not tighten at this time. **See Photo 37.**
42. Install the supplied front crossmember using the supplied 18mm x 120mm bolts, flat washers, and nylock nuts. Do not tighten at this time. **See Photo 38.**

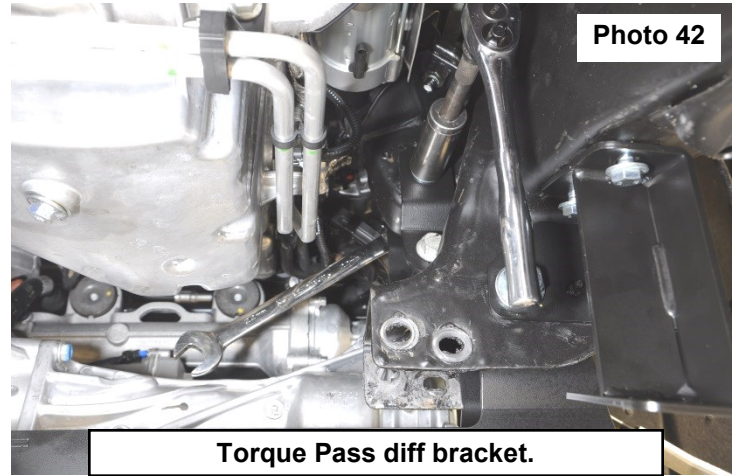
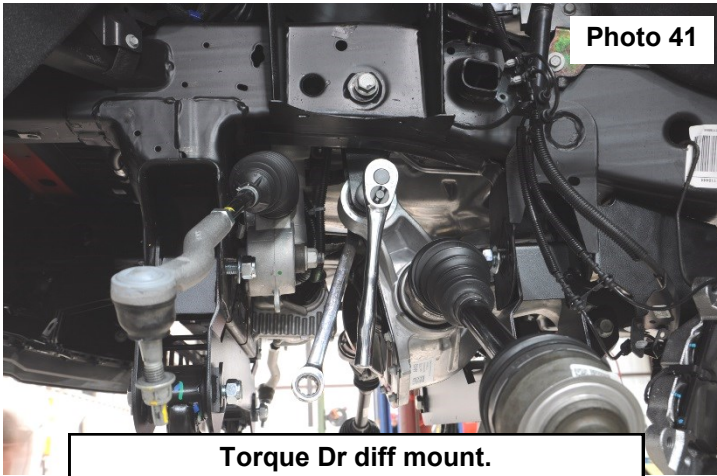


43. Install the lower control arms using the supplied cam bolts and hardware. Do not tighten at this time. **See Photo 39.**
44. Using a 21mm socket and 22mm wrench, torque the upper driver diff mount bolt to 120ft/lbs. **See Photo 40.**



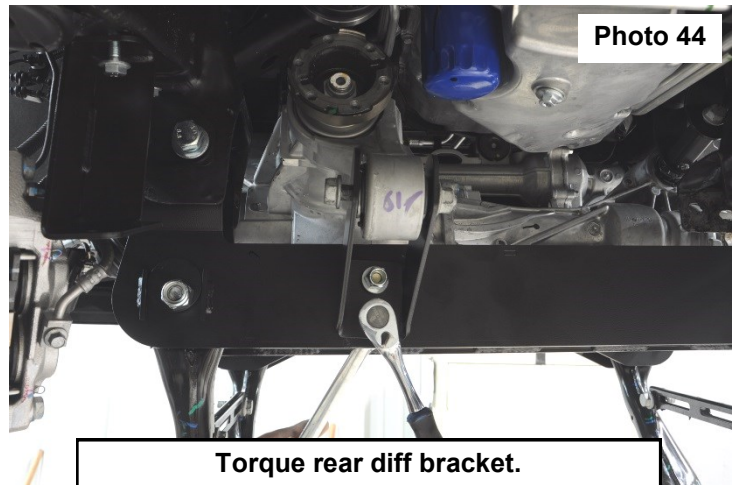
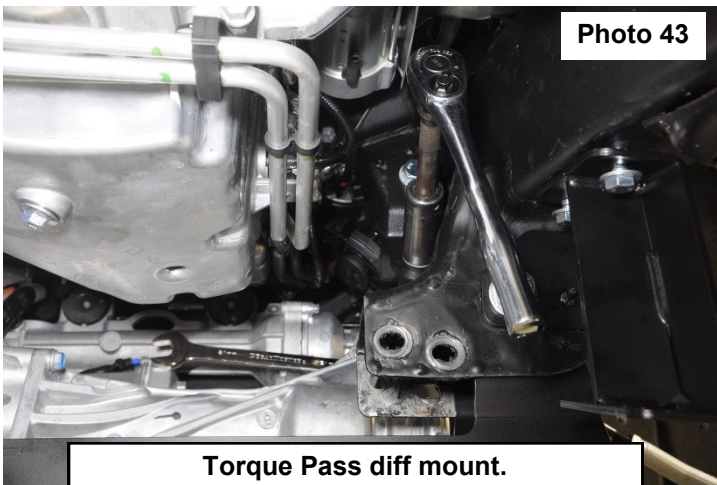
45. Using a 21mm wrench and 22mm socket, torque the dr diff bolt to 85ft/lbs. **See Photo 41.**

46. Using a 21mm wrench and 22mm socket, torque the pass diff drop bolt to 85ft/lbs. **See Photo 42.**



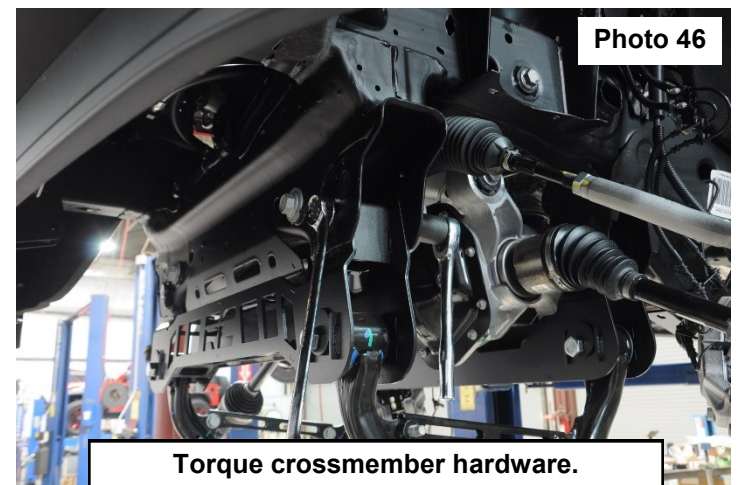
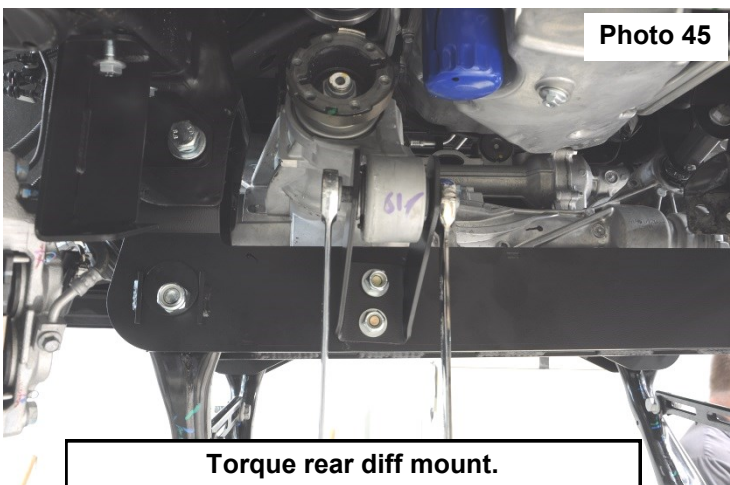
47. Using a 21mm wrench and 22mm socket, torque the pass diff bolt to 85ft/lbs. **See Photo 43.**

48. Using a 3/4" wrench and socket, torque the rear diff bracket hardware to 65ft/lbs. **See Photo 44.**

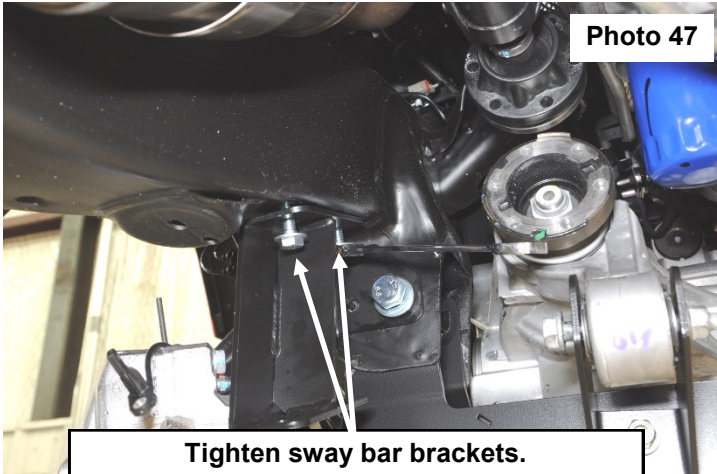


49. Using a 21mm wrench and 22mm socket, torque the rear diff bolt to 126ft/lbs. **See Photo 45.**

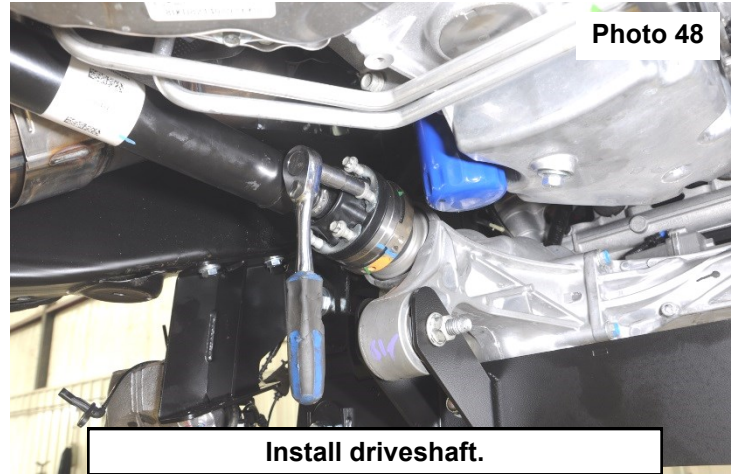
50. Using a 27mm wrench and socket, torque the crossmember bolts to 170ft/lbs. **See Photo 46.**



51. Using a 10mm wrench, tighten the sway bar drop hardware. Torque to 35ft/lbs. **See Photo 47.**
52. Install the front drive shaft on the differential using the factory hardware. Torque to factory specs using a 10mm socket. **See Photo 48.**

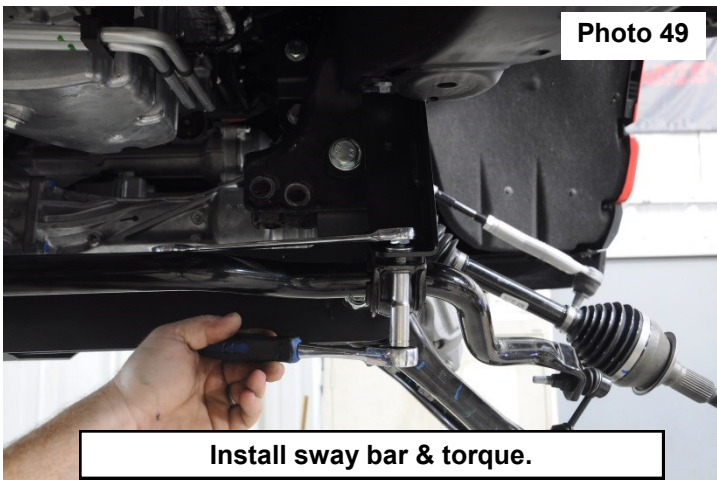


**Tighten sway bar brackets.**

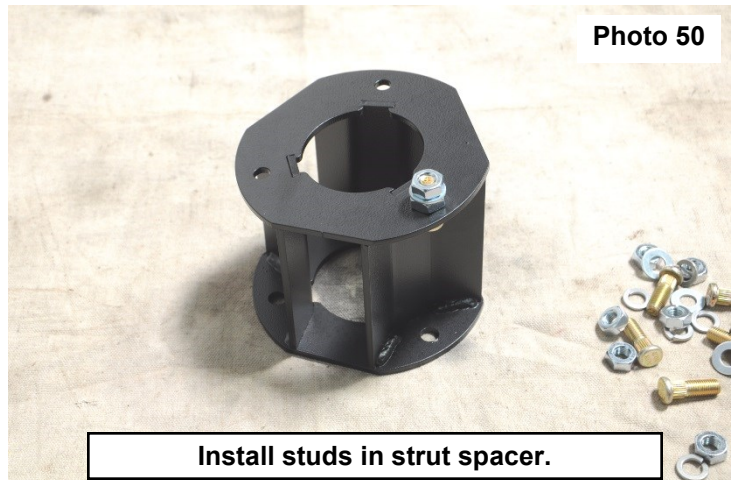


**Install driveshaft.**

53. Install the sway bar on the drop brackets using the supplied 10mm x 35mm bolts, washers, and nylock nuts. Torque to 32ft/lbs using a 17mm wrench and socket. **See Photo 49.**
54. **If installing N3 struts or Vertex coilovers, refer to installation instructions included with those items and skip to step 57.**
55. Install the supplied 10mm studs (10mmstudbag-2) into the strut spacer using the supplied 1/2" jam nut (10mmstudbag-2) between the spacer and the 10mm nut (10mmstudbag-2). Tighten the 10mm nut using a 17mm socket, pulling the stud into the spacer. **Do not use an impact.** **See Photos 50 & 51.**

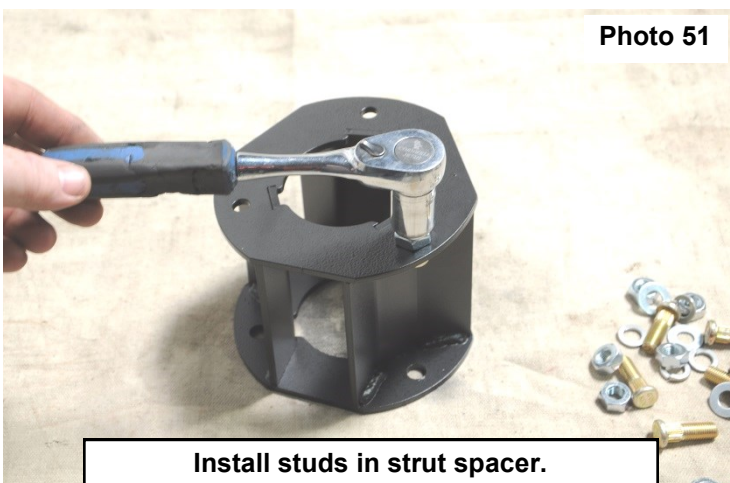


**Install sway bar & torque.**

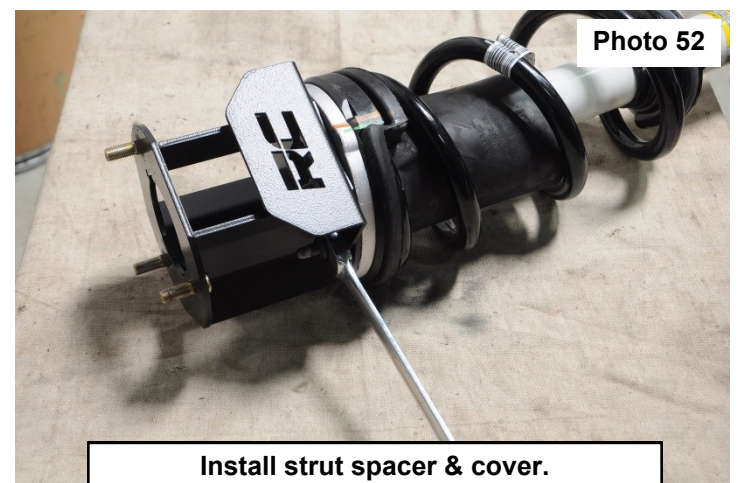


**Install studs in strut spacer.**

56. Install the strut spacer and the supplied strut cover on the factory strut using the factory hardware. Tighten using an 18mm wrench. **See Photo 52.**
- NOTE: Driver side spacer will be marked with a "D" and passenger side will be marked with a "P".**



**Install studs in strut spacer.**



**Install strut spacer & cover.**

57. Install the strut into the upper mount using the supplied 10mm hardware (10mmstudbag-2). Tighten using a 17mm wrench. **See Photo 53.**
58. Install the supplied lower strut spacers between the lower strut barpin and the lower control arm, using the supplied 10mm x 100mm bolts, washers, and nylock nuts. Torque to 32ft/lbs using a 17mm wrench and socket.  
**TAHOE MODELS: See Photo 54.**  
**SUBURBAN MODELS: See Photo 55**  
 You may have to push the lower control arm down to install the spacers.

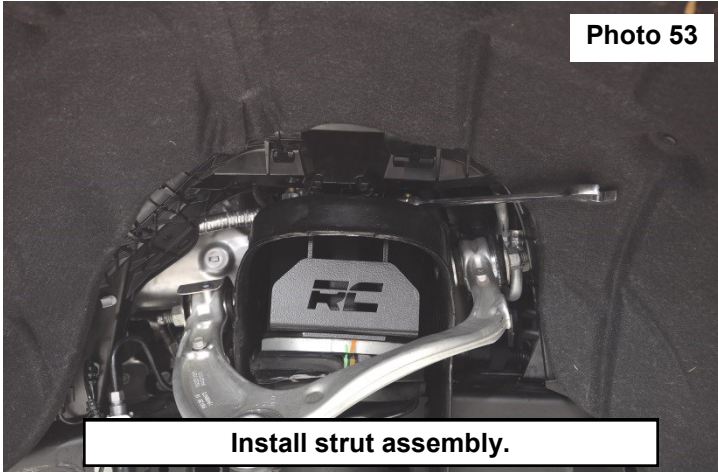


Photo 53

Install strut assembly.

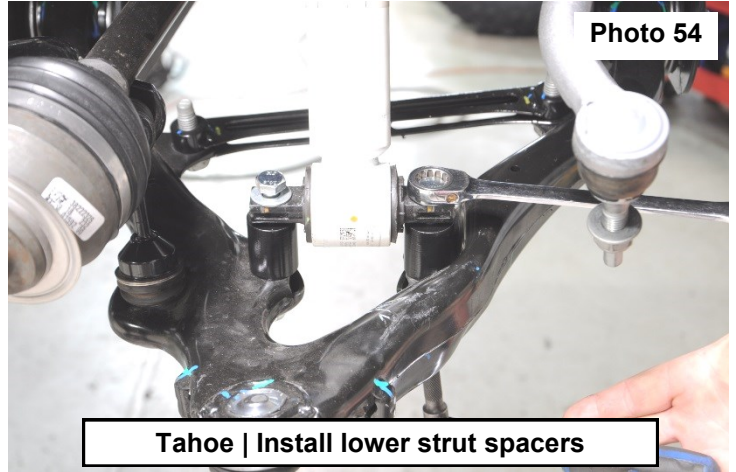


Photo 54

Tahoe | Install lower strut spacers

59. Install the plastic wiring loom using the factory hardware, tighten using a 13mm socket.
60. Using an 18mm socket, remove the hub bearing from the factory knuckle. **See Photos 56 & 57.**

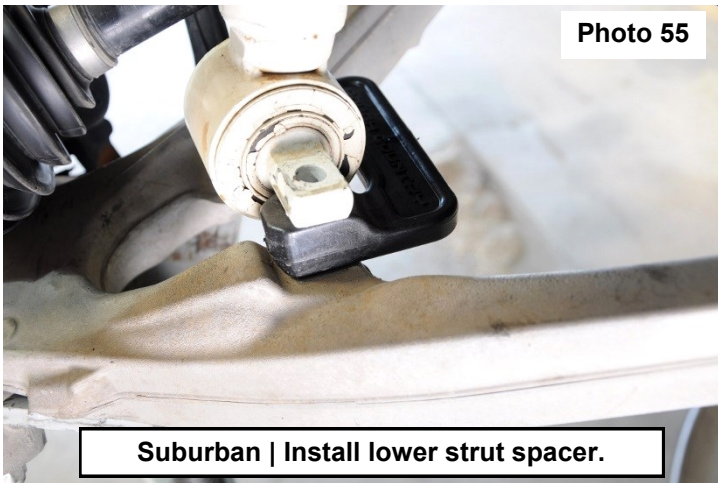


Photo 55

Suburban | Install lower strut spacer.

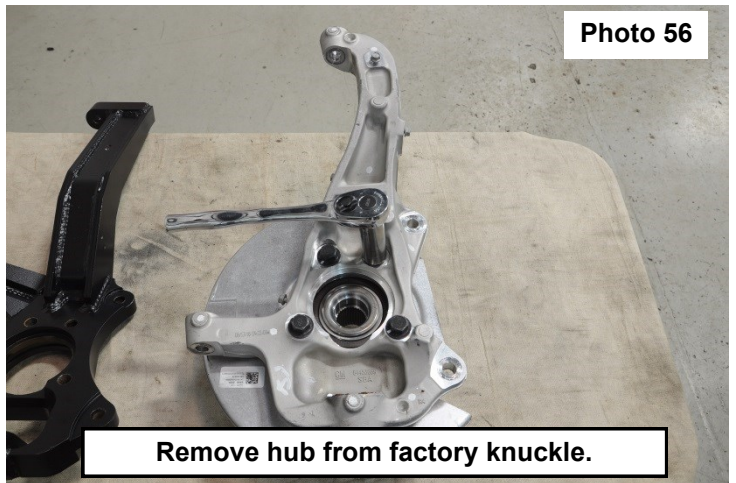


Photo 56

Remove hub from factory knuckle.

61. Carefully remove the hub bearing O-ring from the factory knuckle. Inspect and replace if damaged. **See Photo 58.**

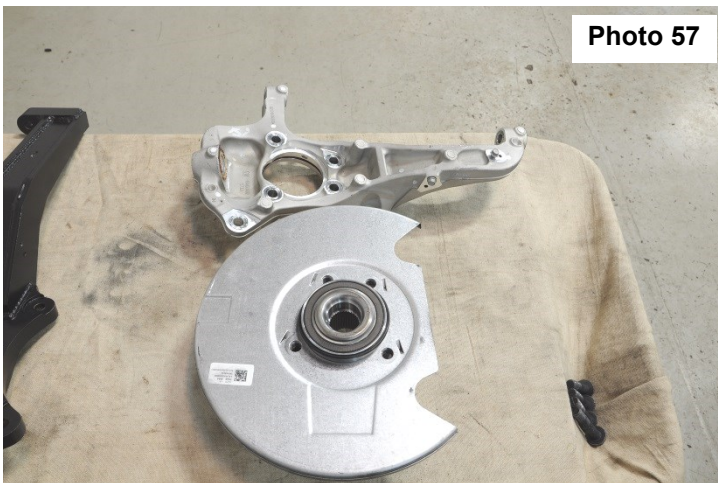


Photo 57

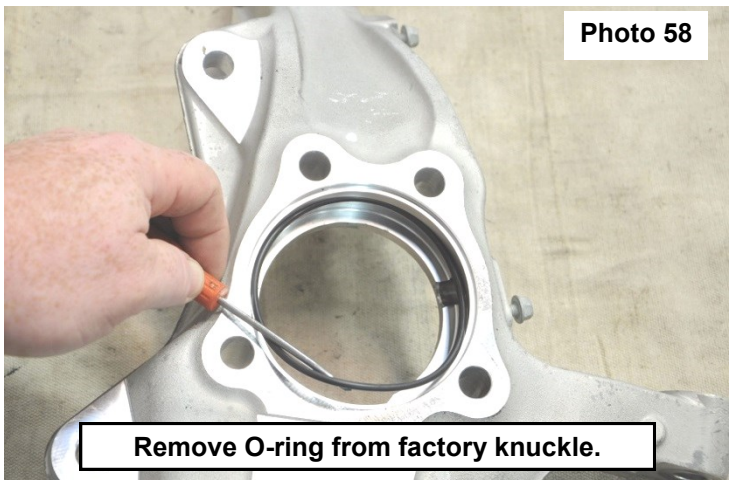
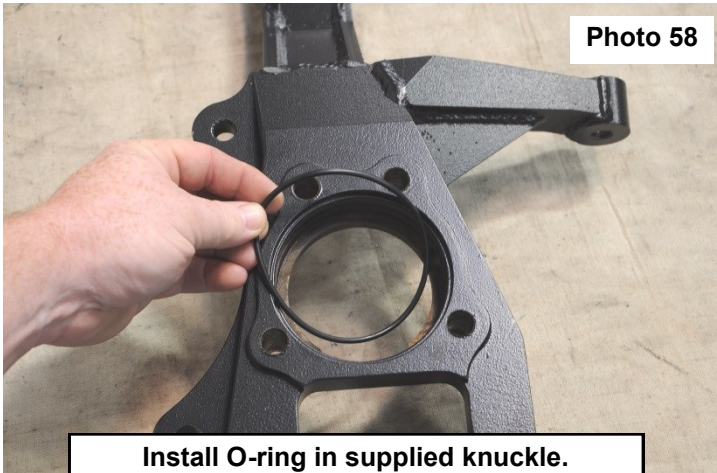


Photo 58

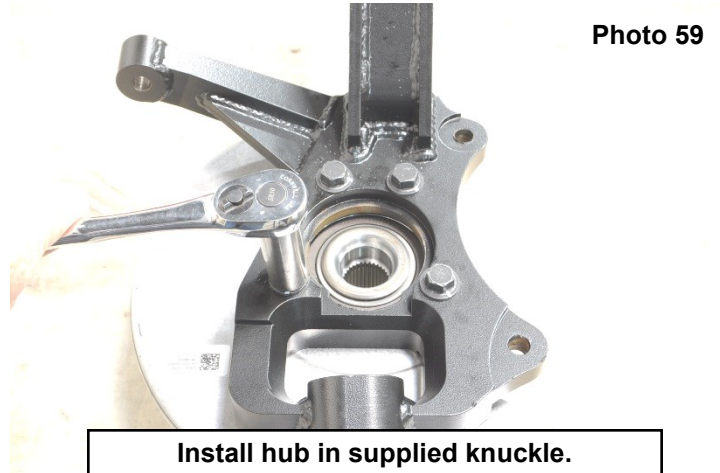
Remove O-ring from factory knuckle.

62. Carefully, install the O-ring in the supplied lifted knuckle. **See Photo 58.**

63. Install the hub bearing in the new knuckle using the factory hardware. Torque to 126ft/lbs using an 18mm socket. **See Photo 59.**



Install O-ring in supplied knuckle.



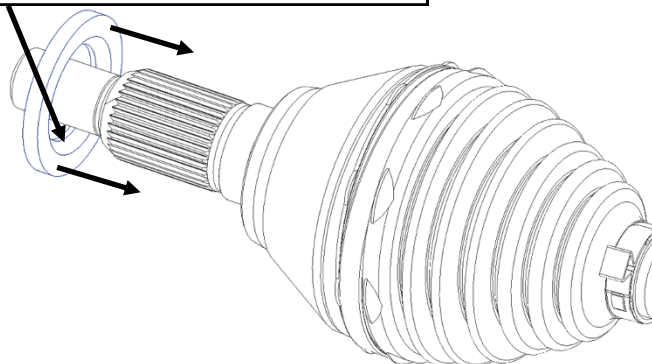
Install hub in supplied knuckle.

64. Install the supplied CV spacer, **chamfer toward the CV joint**, onto the CV shaft. **See Photo 60.**

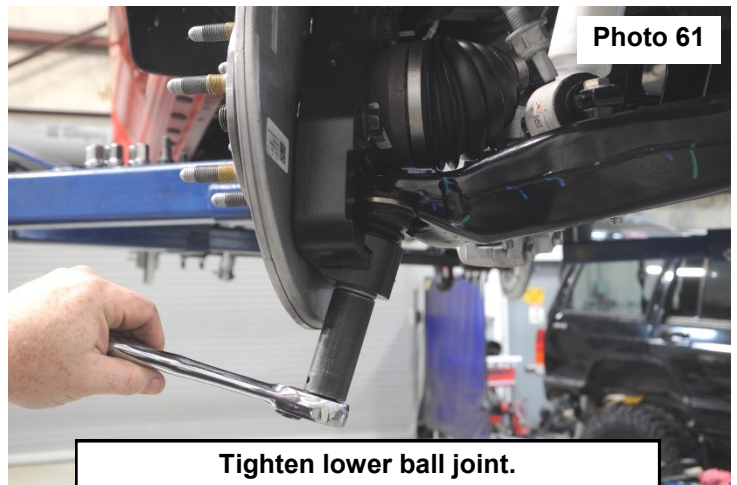
65. Install the knuckle assembly on the lower ball joint, using factory hardware, while installing the CV axle through the hub bearing. Torque using a 24mm socket to 40ft/lbs + 90°. **See Photo 61.**

Note: Chamfer toward CV joint!

Photo 60



Install CV spacer. Note: Chamfer!

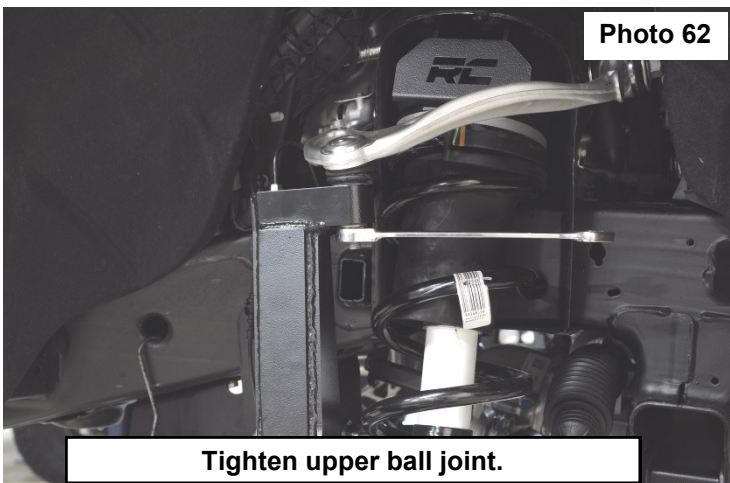


Tighten lower ball joint.

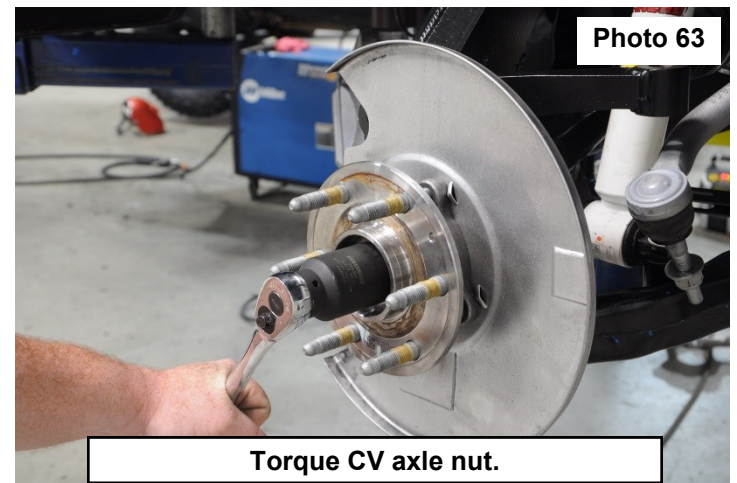
66. Attach the upper ball joint using the factory hardware. Torque to 40ft/lbs + 90° using an 18mm wrench. **See Photo 62.**

67. Attach the sway link to the lower control arm using the factory hardware. Torque to 45ft/lbs using an 18mm socket.

68. Install the CV axle nut and torque to 156ft/lbs using a 36mm socket. **See Photo 63.**



Tighten upper ball joint.

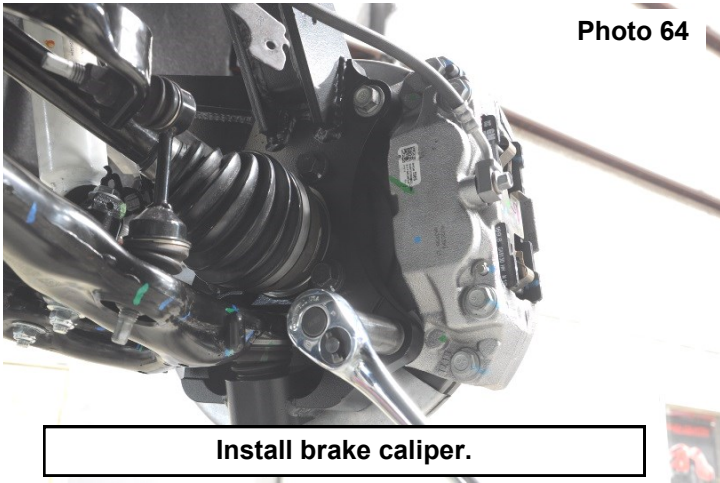


Torque CV axle nut.

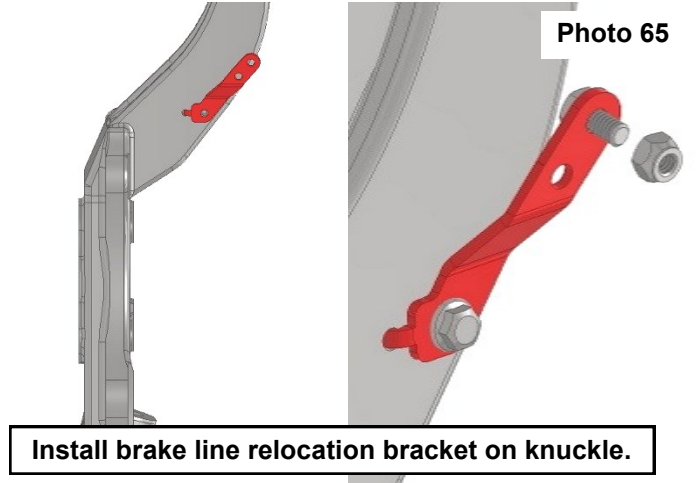
69. Install the rotor using the factory hardware, tighten using a T30 torx.



70. Install the brake caliper using the factory hardware. Plug in brake pad wear sensor. Torque to 130ft/lbs using an 18mm socket. **See Photo 64.**
71. Install the supplied brake line relocation brackets on to the knuckle using the factory hardware. Tighten using a 10mm socket. Attach the factory brake line bracket to the new supplied bracket using the supplied 1/4" x 3/4" bolt and nut. Tighten using a 7/16" socket and wrench. **See Photos 65.**

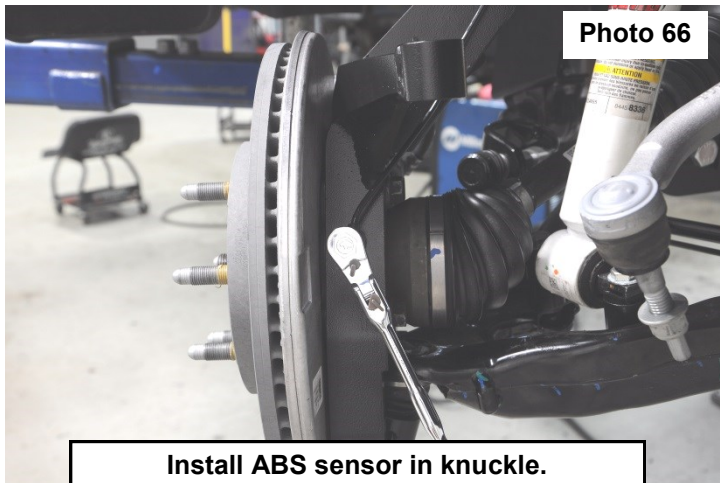


**Install brake caliper.**

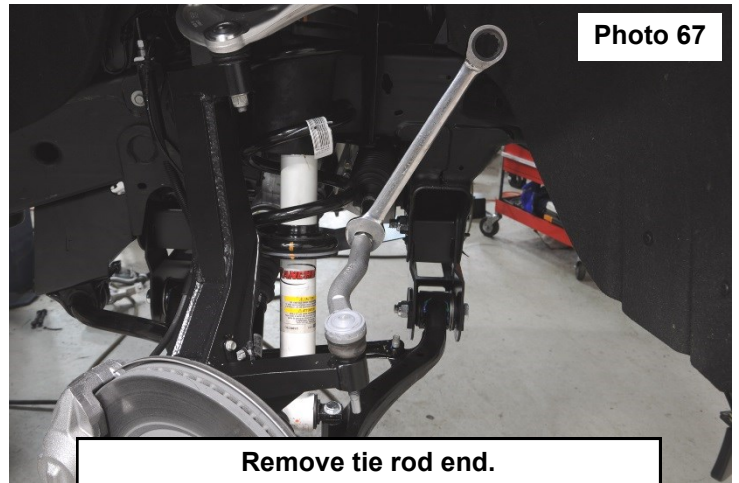


**Install brake line relocation bracket on knuckle.**

72. Attach the ABS sensor to the knuckle using the factory hardware. Tighten using a 10mm socket. **See Photo 66.**
73. Place the tie rod end into the knuckle to hold it, using a 24mm wrench, remove the tie rod end. **See Photo 67.**

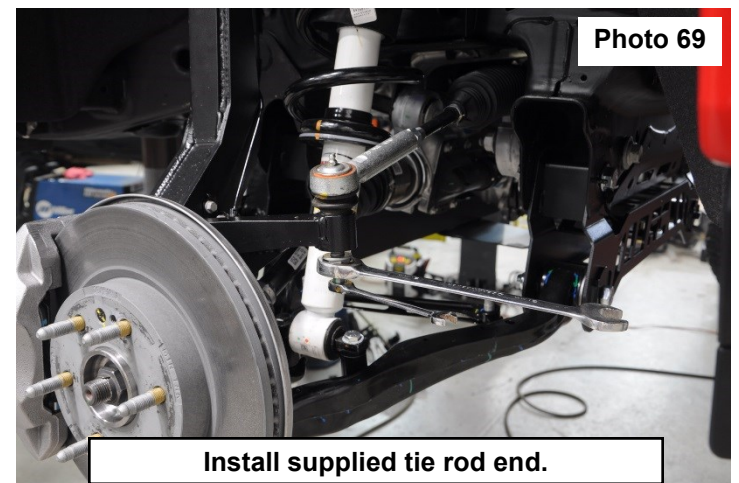
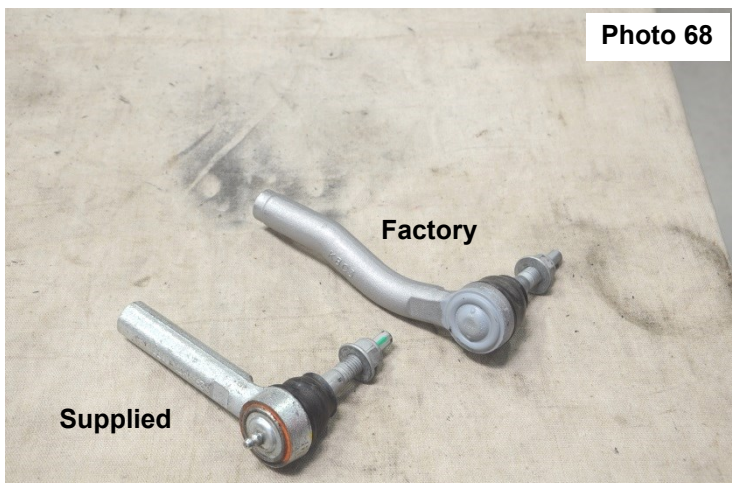


**Install ABS sensor in knuckle.**



**Remove tie rod end.**

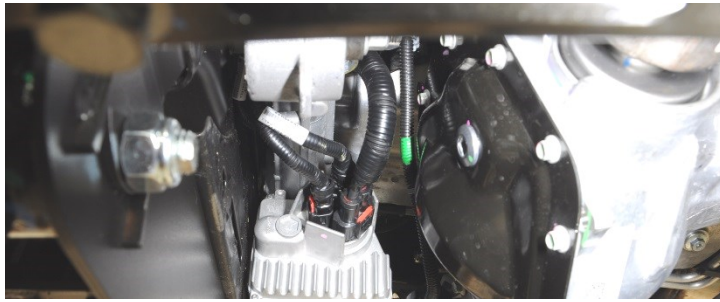
74. **Photo 68** shows the factory tie rod end and the new supplied tie rod end.
75. Install the supplied tie rod end using the supplied hardware. Torque to 32ft/lbs using a 21mm and 10mm wrenches. Tighten the jam nut using a 24mm wrench. **See Photo 69.**



**Install supplied tie rod end.**

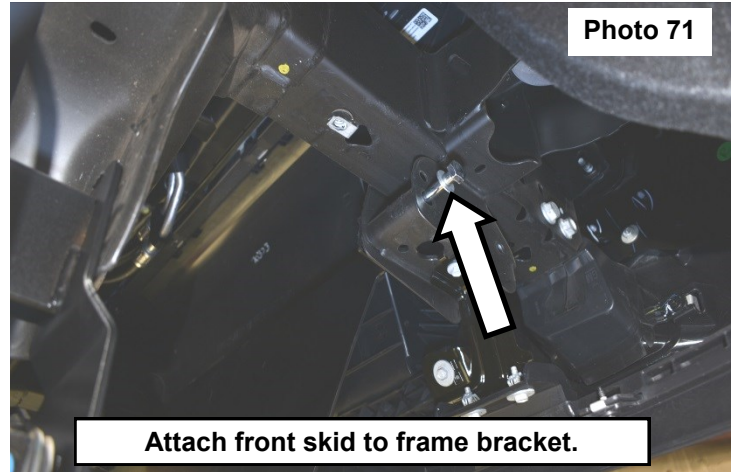


76. Repeat steps 65-82 on the opposite side of the vehicle.
77. Reconnect the plugs to the rack and pinion and the differential actuator. **See Photo 70.**
78. Install the supplied front skid plate on the frame using the supplied 3/8" x 3.75" bolts, flat washers and nylock nuts. Do not tighten at this time. **See Photo 71.**



**Photo 70**

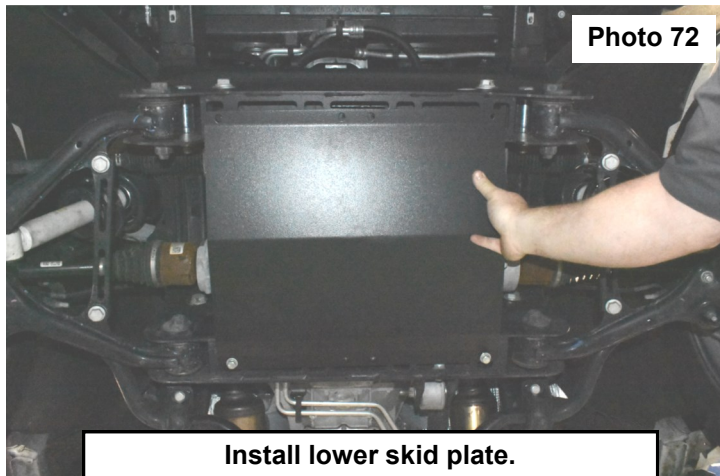
**Plug in rack and pinion and diff actuator.**



**Photo 71**

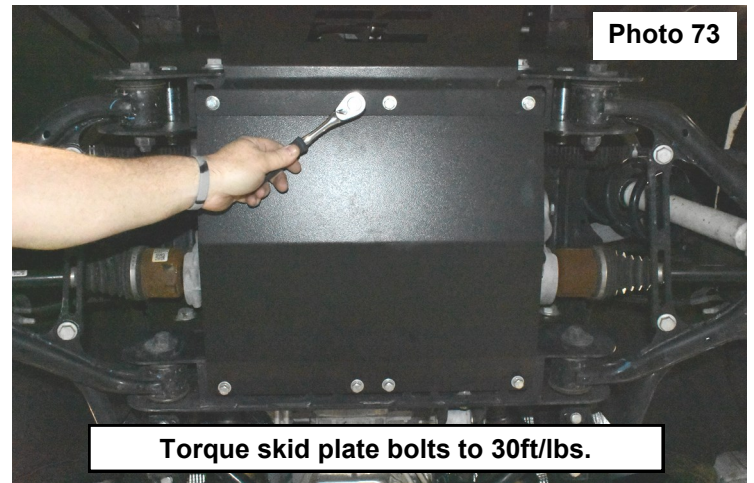
**Attach front skid to frame bracket.**

81. Install the supplied lower skid plate using the supplied 3/8" x 1" bolts, flat washers, and lock washers. Torque to 30ft/lbs using a 9/16" socket. **See Photos 72 & 73.**
82. Torque the front skid plate frame bolts to 30ft/lbs using a 9/16" socket and wrench.



**Photo 72**

**Install lower skid plate.**



**Photo 73**

**Torque skid plate bolts to 30ft/lbs.**

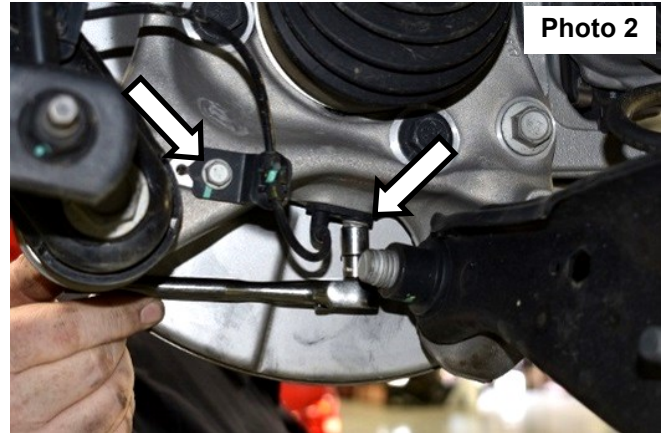
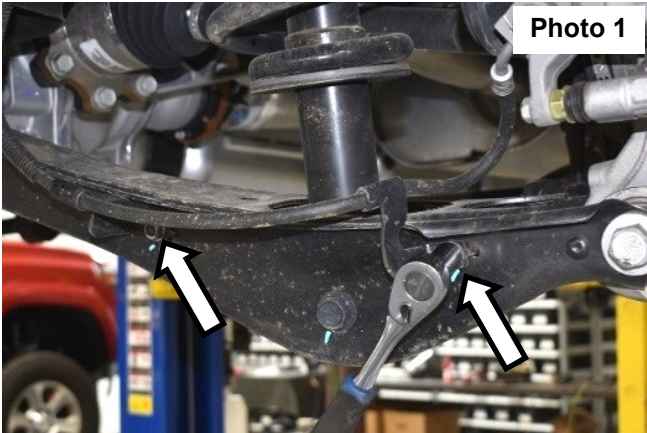
83. Install the wheels and tires.

**⚠ WARNING** Take caution when installing the wheels, making sure they completely clear the brake caliper. Any pressure on the brake caliper from the wheel will cause an error in the brake system. The braking system will not function properly. The vehicle will have to be reset by a GM dealership.

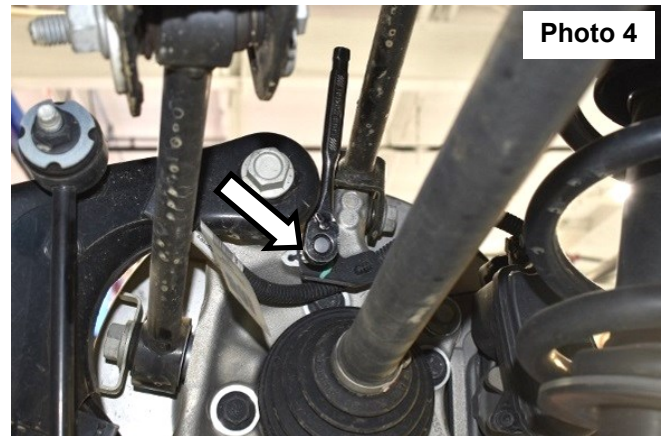
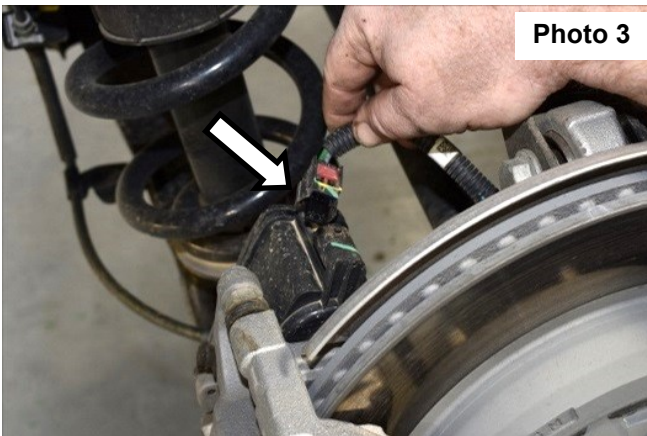
84. Jack up the truck and remove the jack stands. Lower the truck to the ground. Using a 27mm wrench and socket, tighten the cam bolts on the lower control arms. Torque to 240ft/lbs.
85. Connect the battery cables to the battery.

## REAR INSTALLATION INSTRUCTIONS

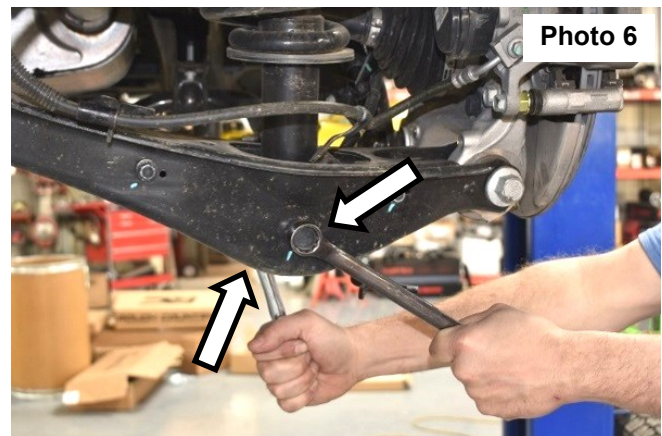
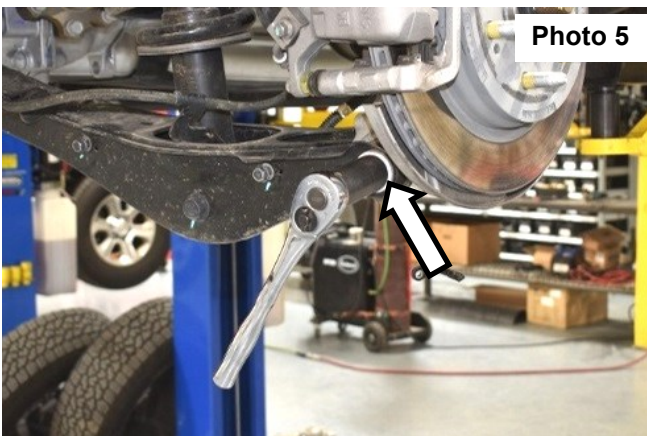
1. Chock the front wheels and jack up the rear of the vehicle. Support the vehicle with jack stands.
2. Remove the tires/wheels. Remove the spare tire using stock tools.
3. Support rear trailing arms with floor jack.
6. Remove brake line from lower control arm using a 13mm socket/wrench. **See Photo 1.**
7. Remove the ABS wire brackets using a 10mm socket/wrench. **See Photo 2.**



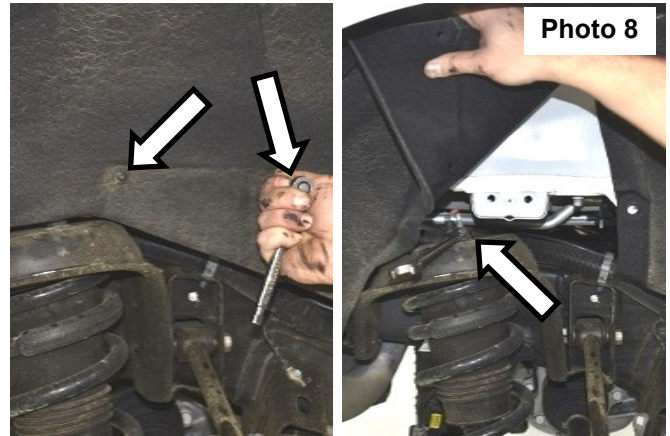
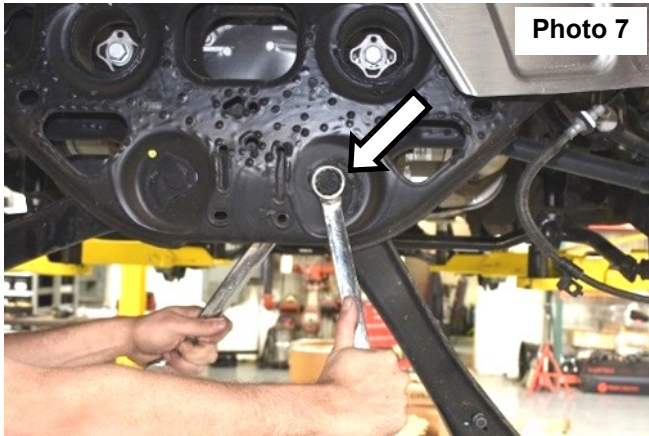
8. Unplug the emergency brake connector from the brake caliper and remove harness from the knuckle using a 10mm socket/wrench. **See Photo 3 and Photo 4.**



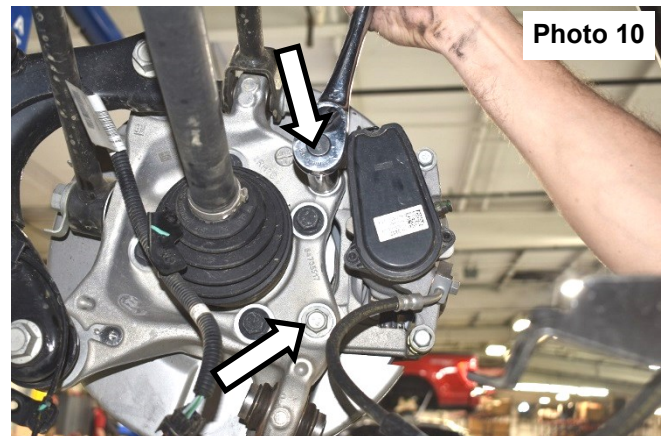
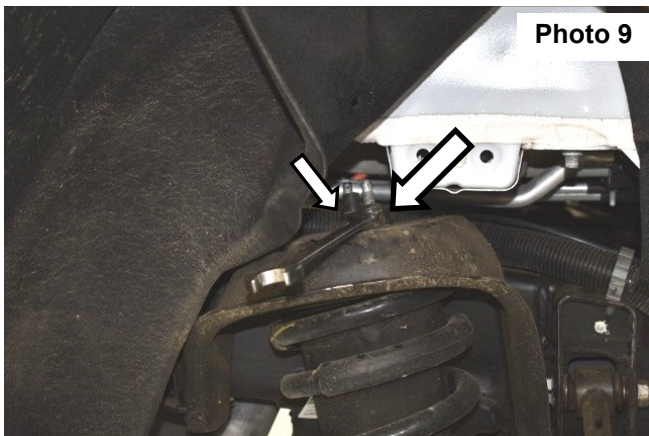
9. Remove the bolt from the lower control arm at the knuckle using a 24mm socket/wrench. **See Photo 5.**
10. Remove the bolt from the lower control arm at the strut using two 21mm wrenches. **See Photo 6.**



11. Remove the cam bolt from the lower control arm at the frame using two 1 1/16" wrenches. Remove the lower control arm. **See Photo 7.**
12. Remove bolts securing the inner fender liner using a T10 Torx bit to gain access to the upper strut bolts. **See Photo 8.**



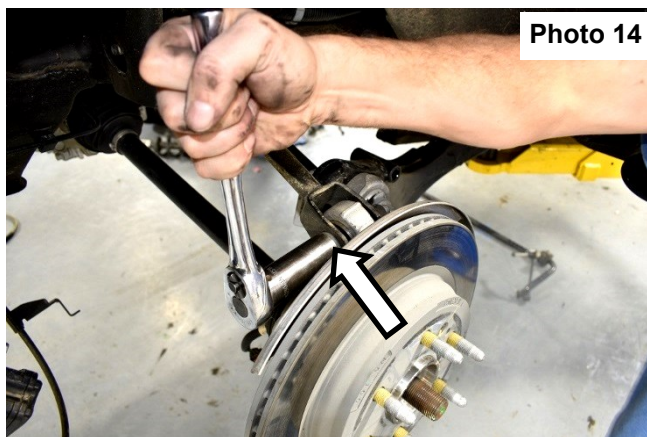
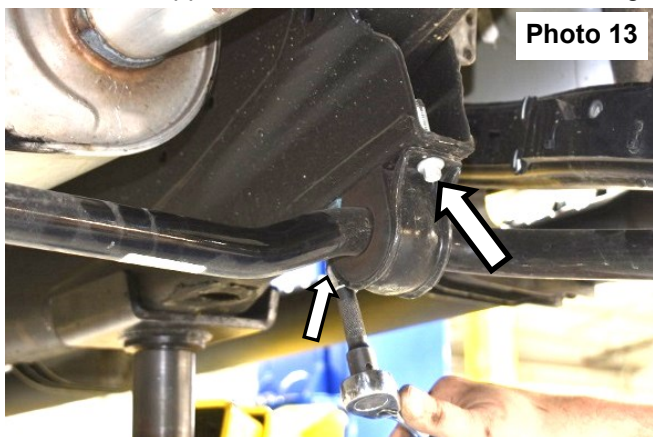
13. Remove the nuts from the upper strut using an 18mm wrench. **See Photo 9.** Remove strut from vehicle.
14. Remove the brake calipers using an 18mm socket/wrench. **See Photo 10.**



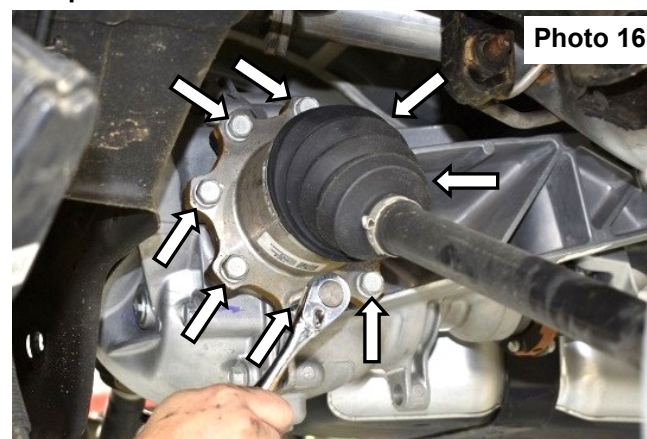
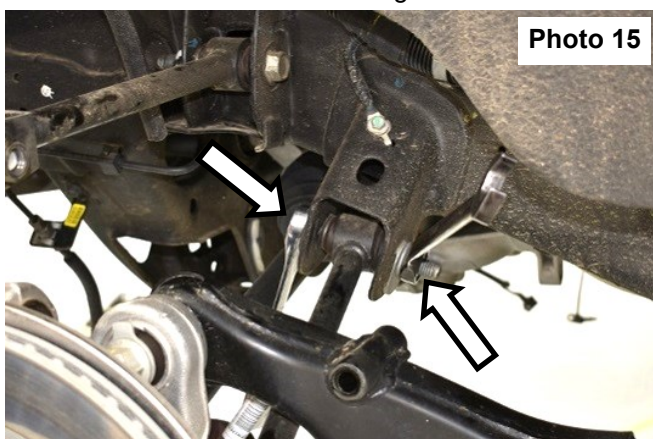
15. Remove the axle nut using a 36mm socket. **See Photo 11.**
16. Remove the sway bar link from the trailing arm using an 18mm socket/wrench. **See Photo 12.**



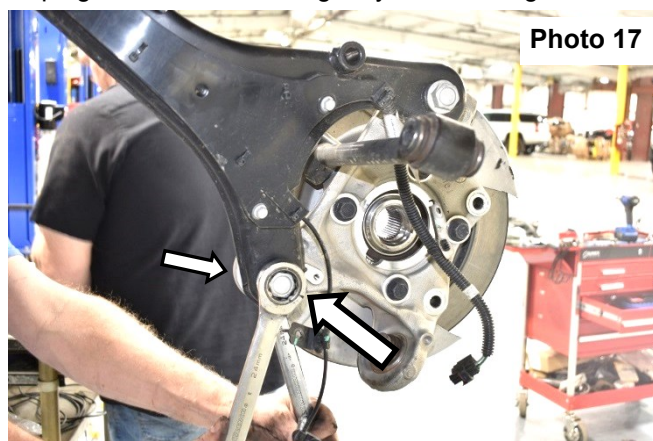
17. Remove the sway bar from the frame using a 10mm socket/wrench. **See Photo 13.**  
18. Remove the upper control arm from the knuckle using a 21mm socket/wrench. **See Photo 14.**



19. Remove the toe bar from the frame pocket using two 21mm wrenches. **See Photo 15.**  
20. Remove the 8 CV axle bolts using an 18mm socket/wrench. **See photo 16.** Remove the axles.

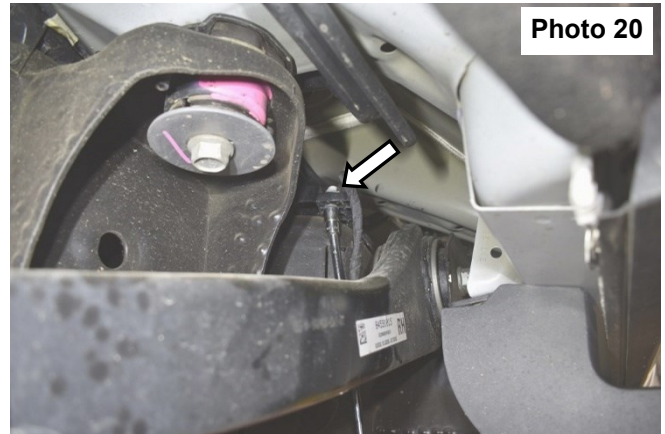
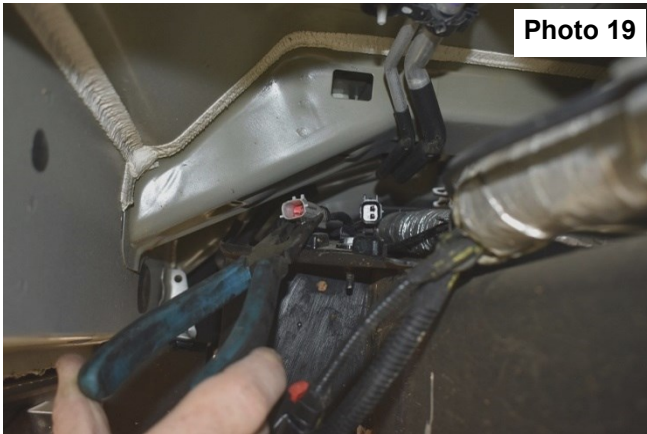


21. Remove the knuckle from the trailing arm using a 24mm socket/wrench. **See Photo 17.**  
22. Unplug the ABS and emergency brake wiring harnesses at forward location above trailing arms. **See Photo 18.**

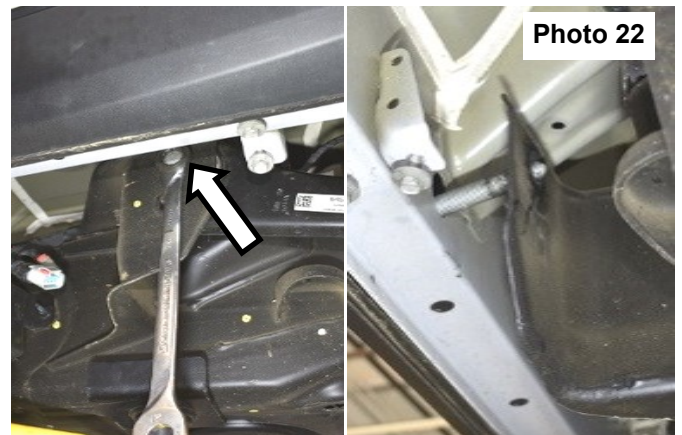


23. Remove the ABS and e-brake wiring plugs from the harness for rerouting. **See Photo 19.**

24. Remove the bolt holding the ABS and e-brake wiring harness on the top of the trailing arm pocket. **See Photo 20.**

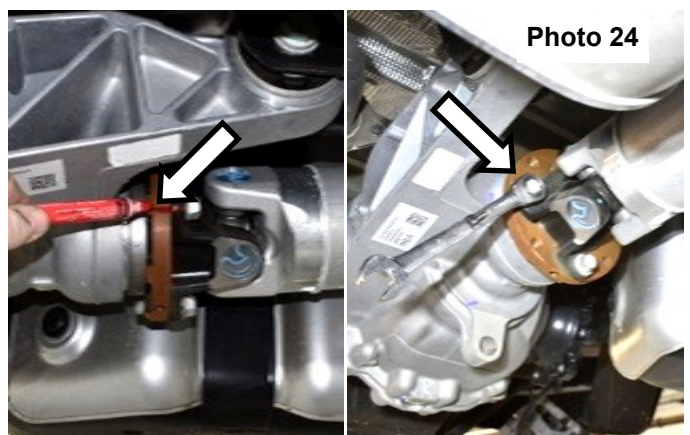
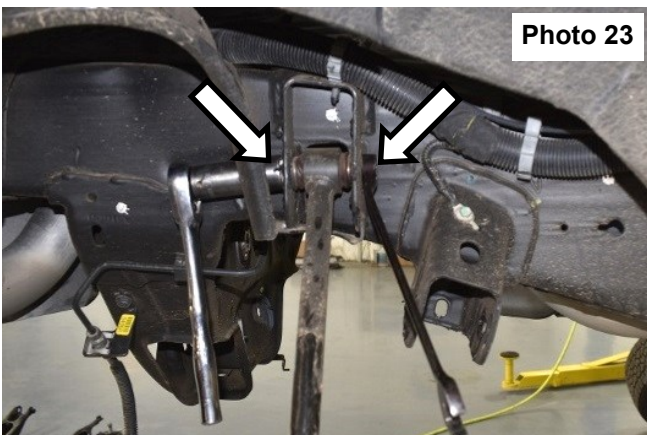


25. Remove the body plug on the opposite side of the trailing arm bolt and then remove the bolt using a 21mm wrench to remove the trailing arm. **See Photo 21 and Photo 22.**



26. Remove the upper control arm from the frame using two 21mm socket/wrenches. **See Photo 23.**

27. Mark the driveshaft and disconnect from rear pinion using a 15mm socket/wrench. **See Photo 24.** Hang out of the way.  
**NOTE: SUPPORT THE DRIVESHAFT WITH A SUITABLE STRAP OR JACK TO PREVENT DAMAGE.**



28. Support the differential and remove the front diff bolt using two 21mm wrenches. **See Photo 25.**  
29. Remove the vent hose from the top of the differential. **See Photo 26.**

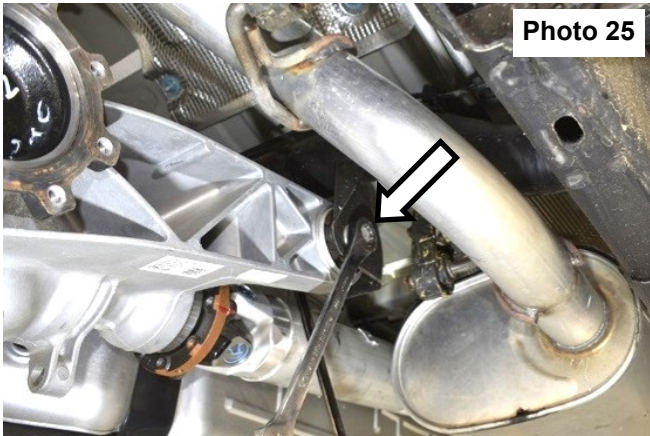


Photo 25

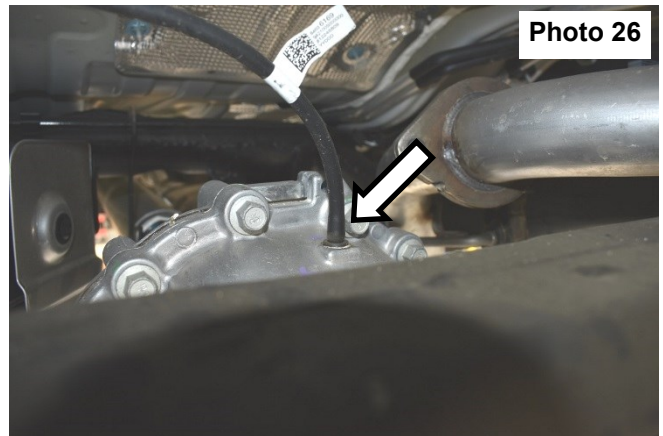


Photo 26

30. Remove the two rear diff bolts using a 21mm socket and lower the diff from the vehicle. **See Photo 27.**  
31. Use supplied templates at the back of instructions to mark the lines to cut the lower control arm pockets on the front and rear sides of the control arm pockets. **See Photo 28 and Photo 29.**

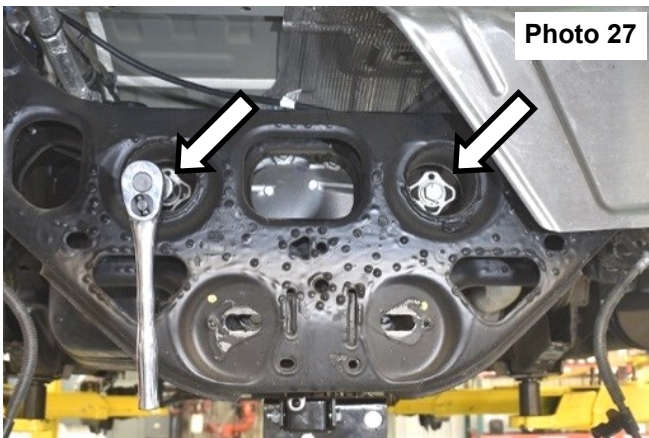


Photo 27

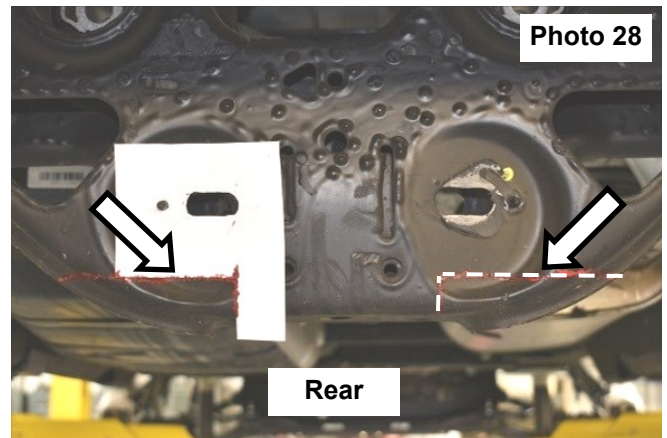


Photo 28

Rear

32. Connect the lines from the front and rear markings underneath the lower control arm pockets. **See Photo 30.**

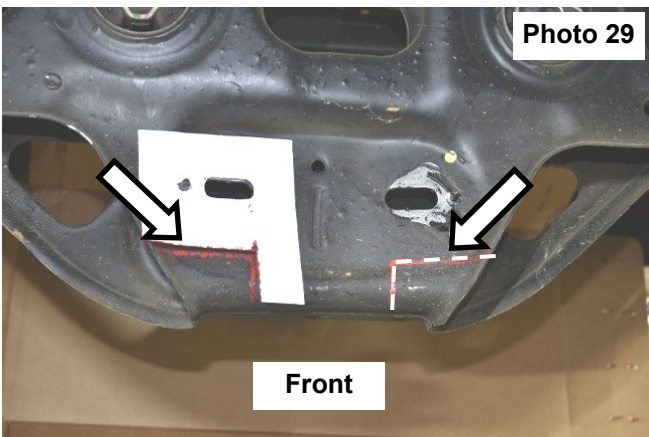


Photo 29

Front

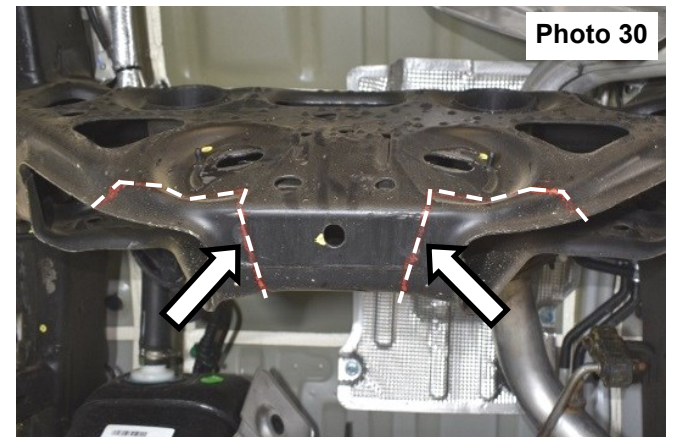
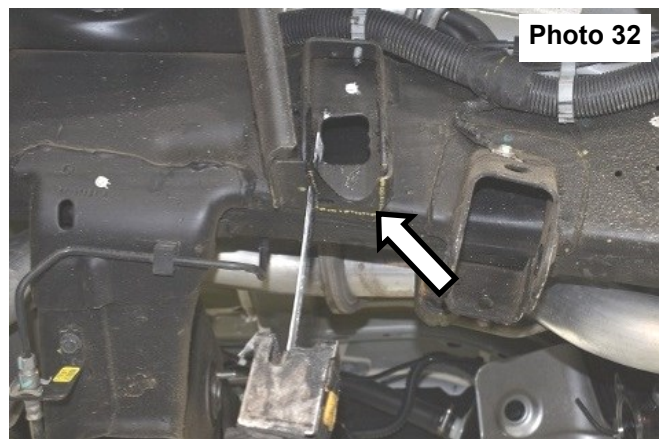
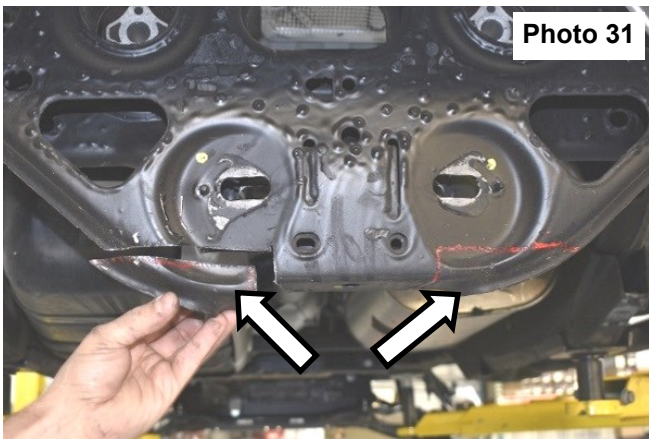


Photo 30

33. Cut out the lower portion of the lower control arm pockets using a reciprocating saw. See Photo 31.

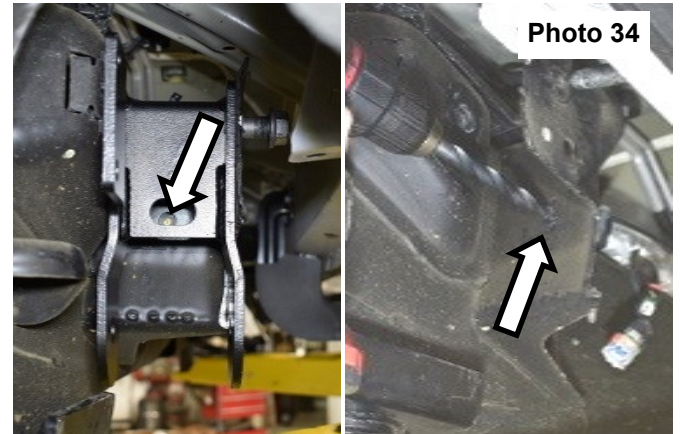
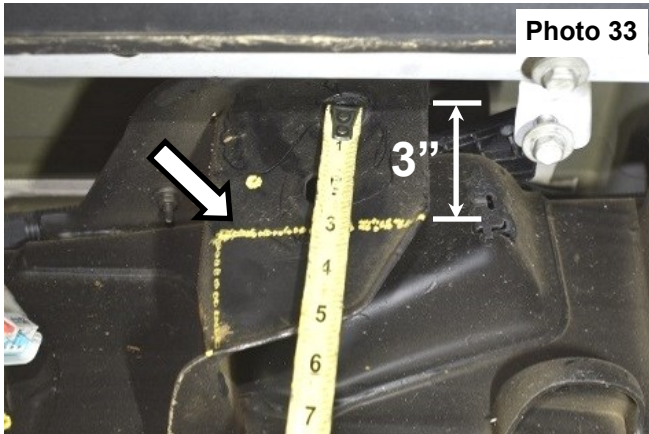
34. Mark and cut the lower tab out of the upper control arm pocket. See Photo 32.



35. Measure 3" down from the center of the bolt hole on the trailing arm pocket and mark a horizontal line. Mark a vertical line down the front edge. Cut using a reciprocating saw. The steps may need to be removed for this cut. See Photo 33.

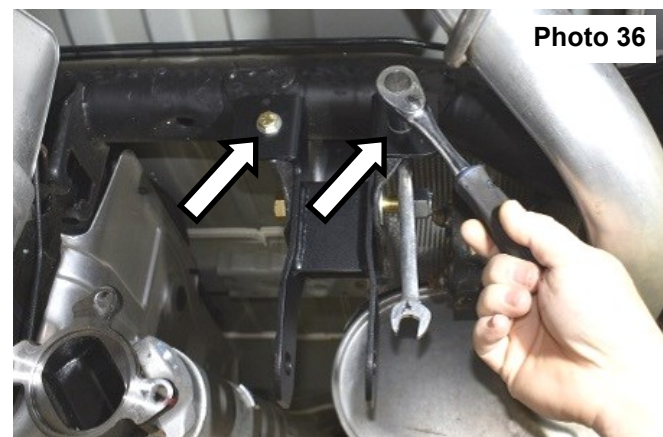
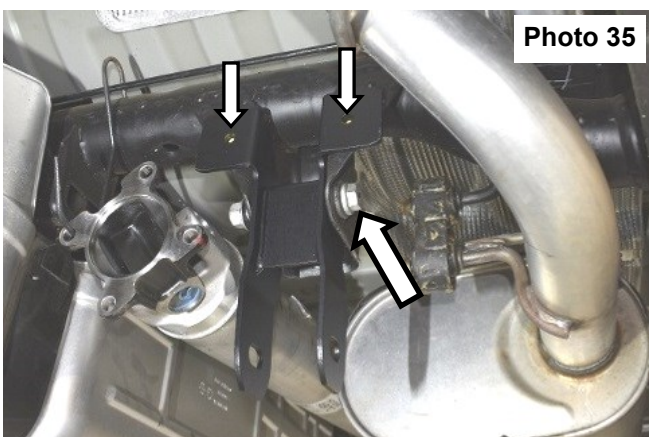
**▲ NOTICE** NOTE: After cutting, grind (or sand) all edges and paint edges to prevent rusting.

36. Place the trailing arm bracket in the pocket and mark lower hole. NOTE: Make sure bracket is flush with the front of the pocket. Remove bracket and drill using 1/2" bit. See Photo 34.

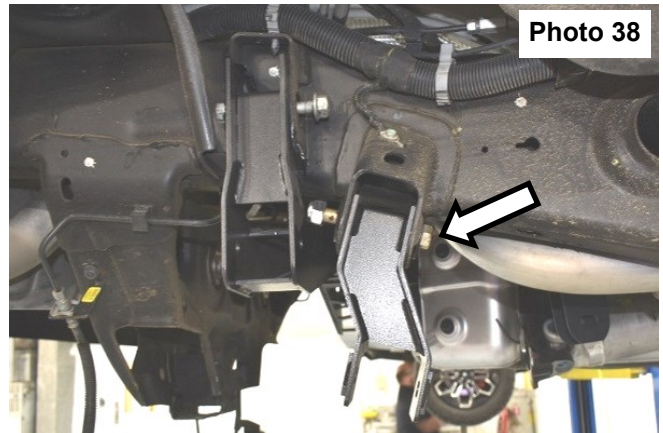
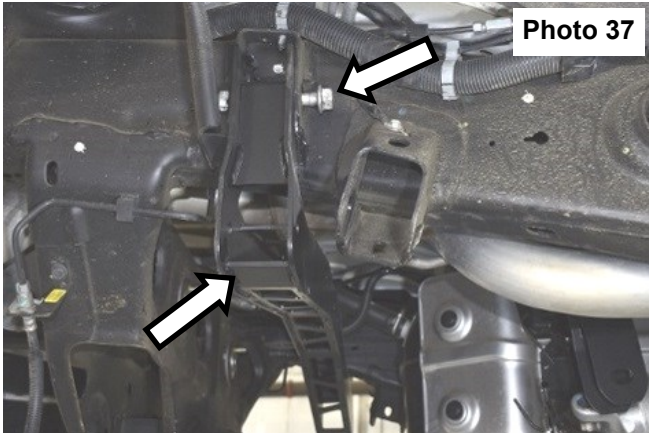


37. Install the front differential bracket using the supplied 5/8"x4" bolt, nuts, and washers using two 15/16" (24mm) wrenches (10900BAG1). NOTE: Make sure diff bracket is flush with factory flanges. Use vice grips if needed. Mark the 2 upper holes and drill using a 3/8" drill bit. See Photo 35.

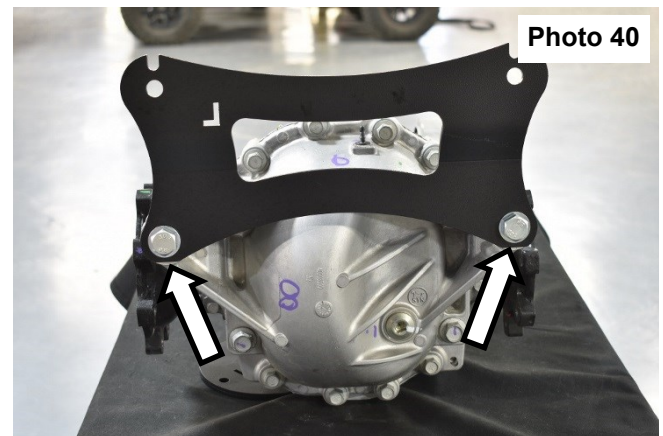
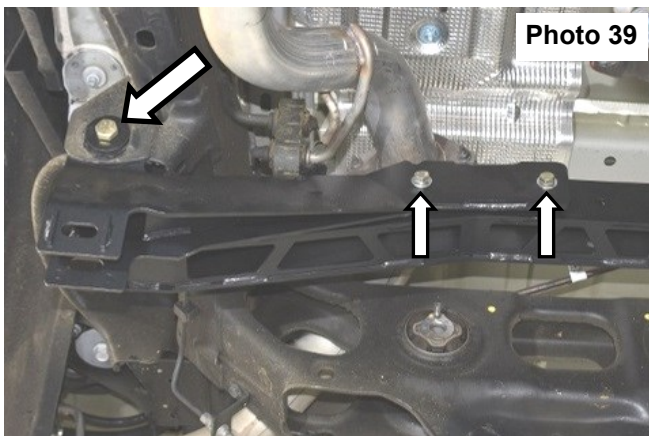
38. Install supplied 3/8"x1 1/4" bolts, nuts, and washers(10900BAG1). Tighten using 9/16" socket/wrench. See Photo 36.



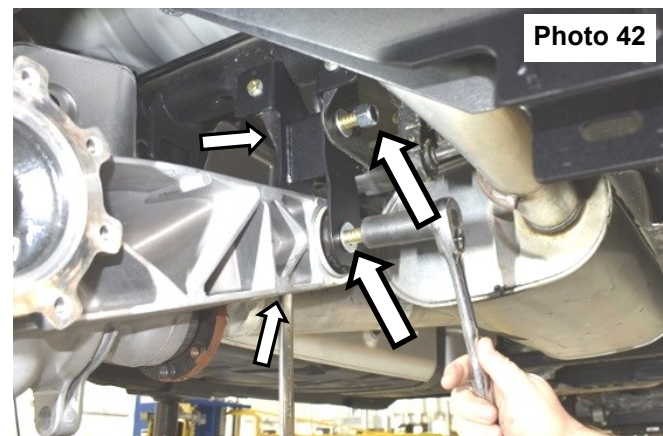
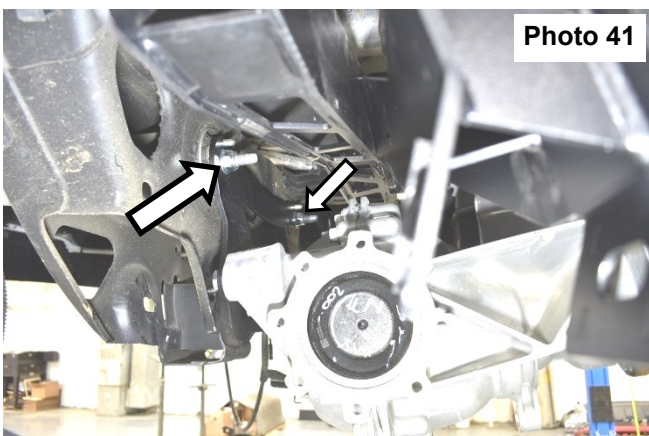
39. Install the upper control arm cross-member using stock bolts. Do not tighten at this time. **See Photo 37.**
40. Install the toe bar drop bracket using the supplied 9/16" bolts with 3/16" thick painted washers at the toe bar pocket using 21mm and 22mm wrenches and 7/16" bolts, nuts, and washers at the crossmember (10900BAG4). **See Photo 38 and Photo 39.**
- Now, go back and tighten the cross-member stock bolts using a 21mm socket/wrench. **See Photo 37 again.**



41. Install the rear differential bracket to the differential with the supplied 14mm bolts and washers using a 22mm socket/wrench (10900BAG1). **See Photo 40.**

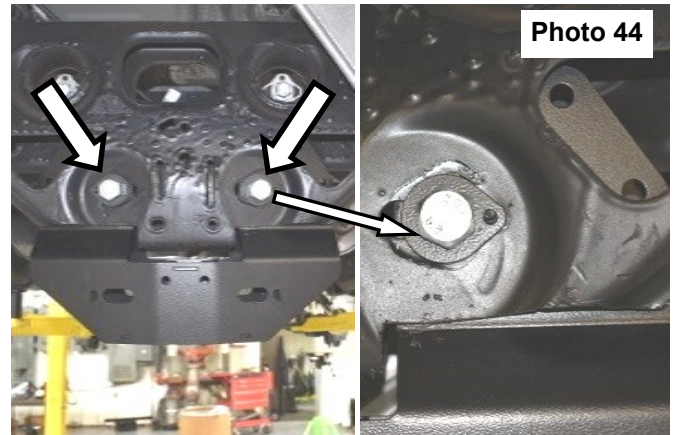
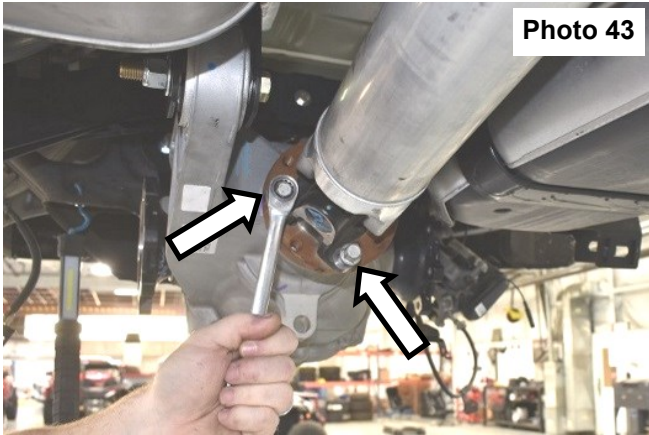


42. Install the differential using the stock bolts with supplied 14mm nuts and washers for the rear and supplied 5/8" bolt for the front. Use a 21mm and 22mm socket/wrench for the 14mm and use two 24mm socket/wrench for the 5/8" bolt (10900BAG1). **See Photo 41 and Photo 42.**

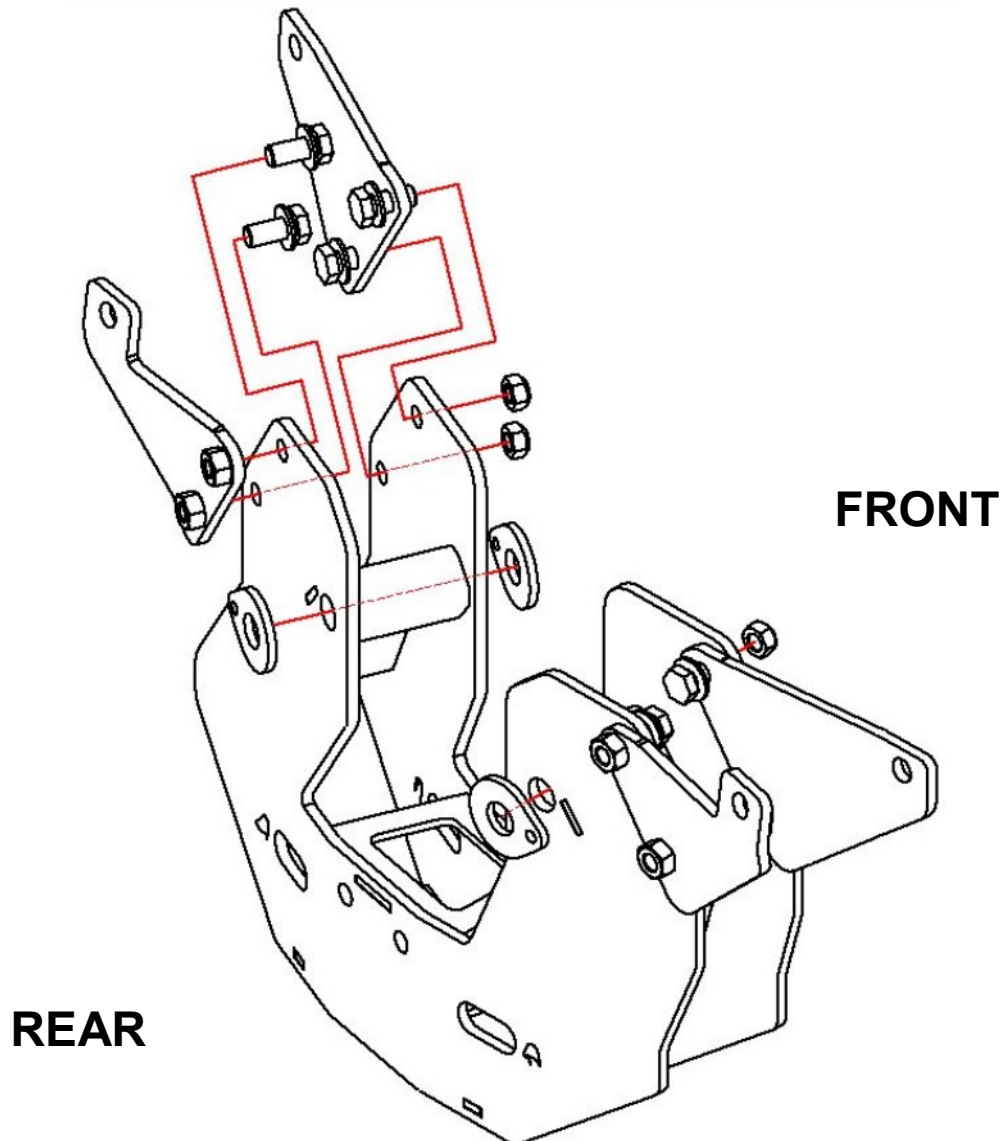




43. **Reinstall the differential vent hose.** You may need to pull slack from the frame.
44. Install the rear driveshaft with stock bolts using a 15mm socket/wrench. **See Photo 43.**
45. Install rear lower control arm bracket onto truck using the supplied 18mm bolts with the lock out washers (10900BAG2). **NOTE: The small hole on the lock out washer goes on the alignment tab.** **See Photo 44.** Do not tighten at this time.



46. Refer to the CAD drawing below and **Photos 45 - 50.** for installing the lower control arm support brackets.



47. Install the lower control arm support brackets with 7/16"x1" bolts and washers using 5/8" and 11/16" wrenches (10900BAG2). **See Photos 45 - 50.**
48. The support bracket WITH the welded nuts goes toward the rear of the vehicle. Only install the bolts and washers for the welded nuts at this time. **See Photo 46.**

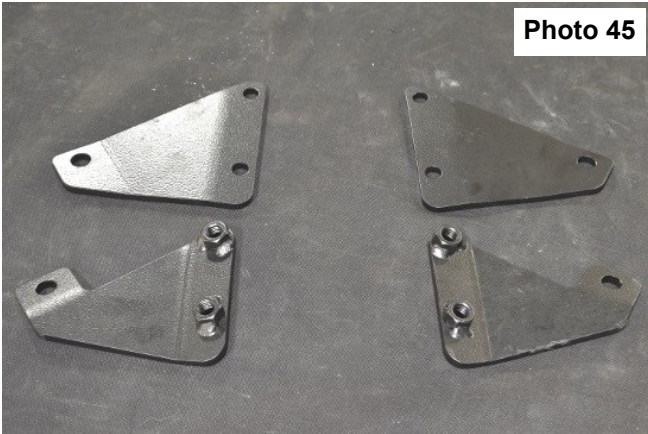


Photo 45

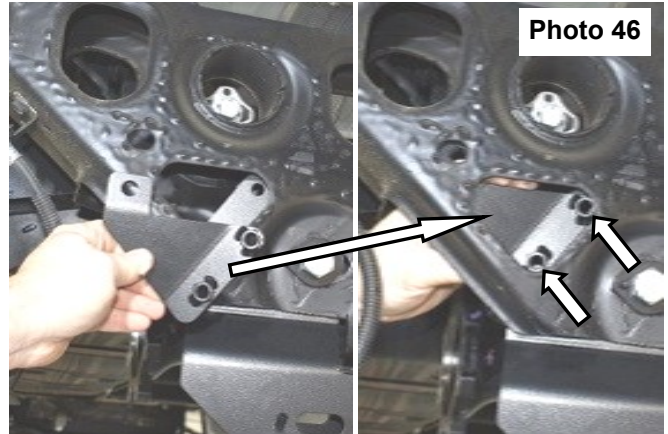


Photo 46

49. The support bracket WITHOUT the welded nuts goes toward the front of the vehicle. **See Photo 47.** Access for the nuts at this locations can be reached through the large square hole in **Photo 49.**
50. Install the 1/2" bolts, nuts, and thick washers through the support brackets WITHOUT the welded nuts using a 3/4" socket/wrench (10900BAG2). **See Photo 48.**

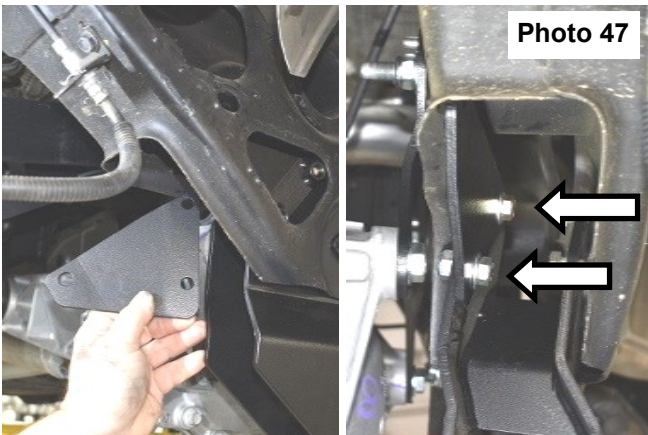


Photo 47

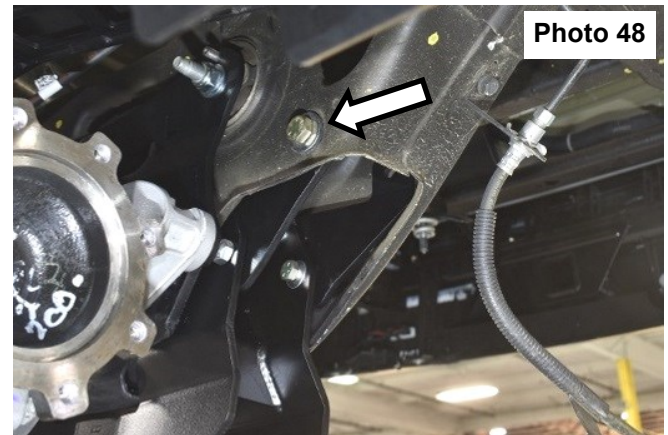


Photo 48

51. Go back and tighten the 18mm bolts in the lower control arm bracket using a 1 1/16" socket/wrench. **See Photo 49.**
52. Install the skid plate with the 1/2" bolts, nuts, and thick washers (10900BAG2) through the support brackets WITH the welded nuts and install the 7/16" bolts, nuts, and washers (10900BAG3) through control arm bracket. **See Photo 50.**

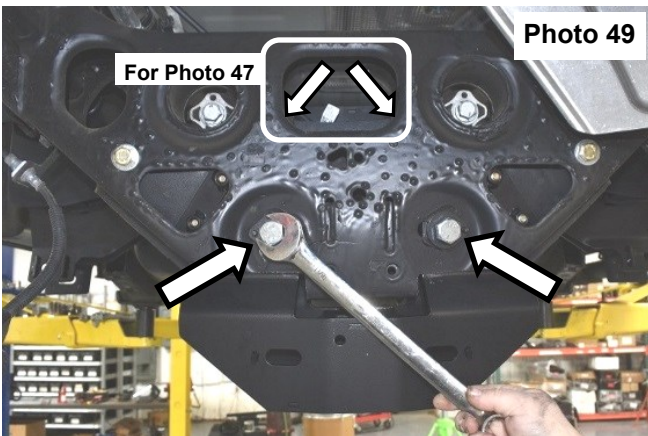


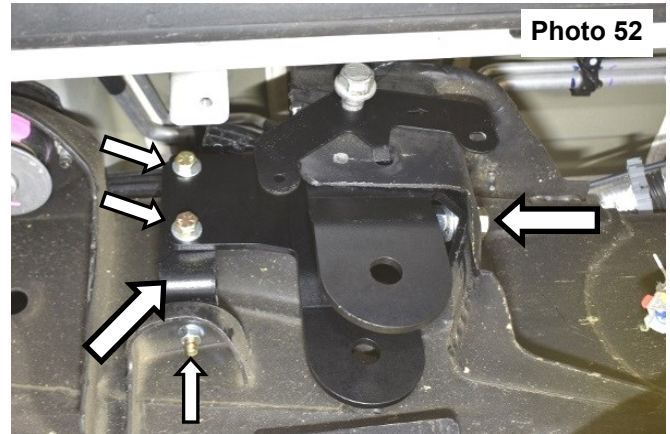
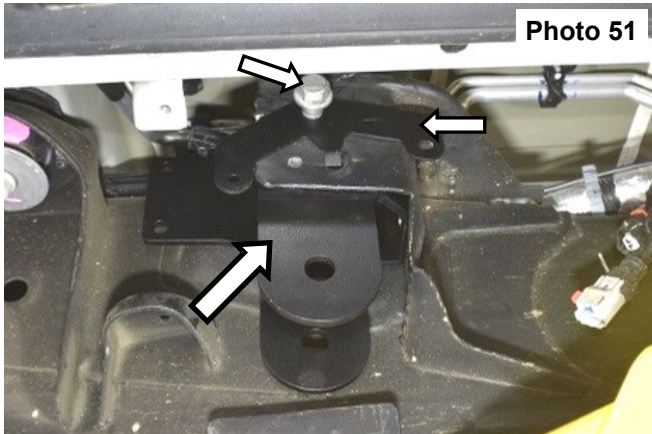
Photo 49

For Photo 47

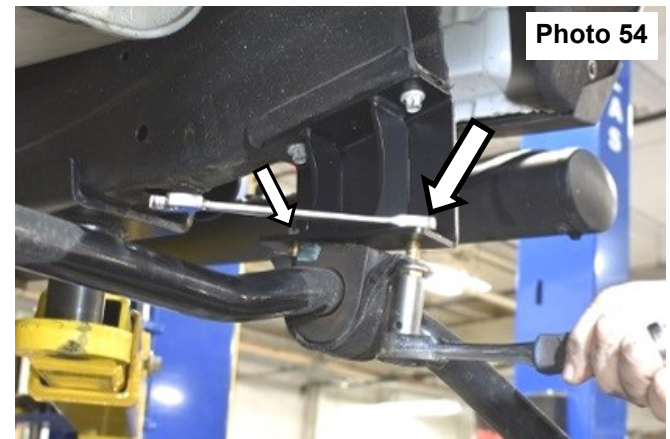
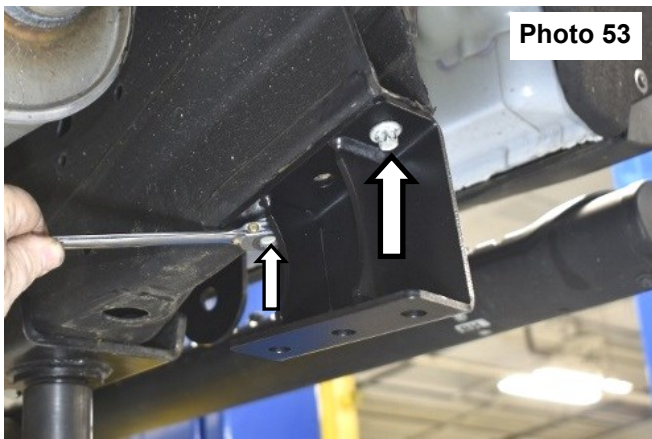


Photo 50

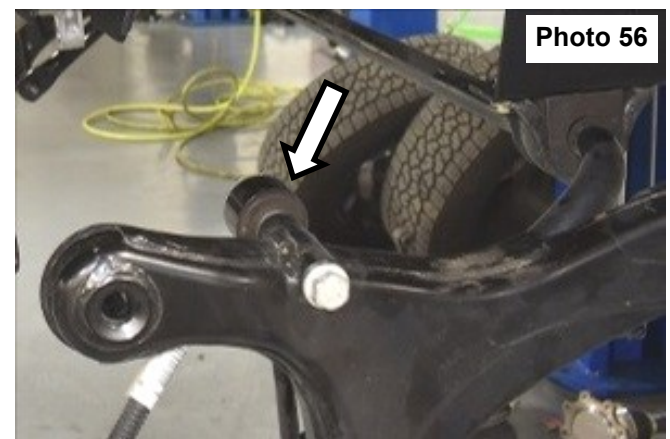
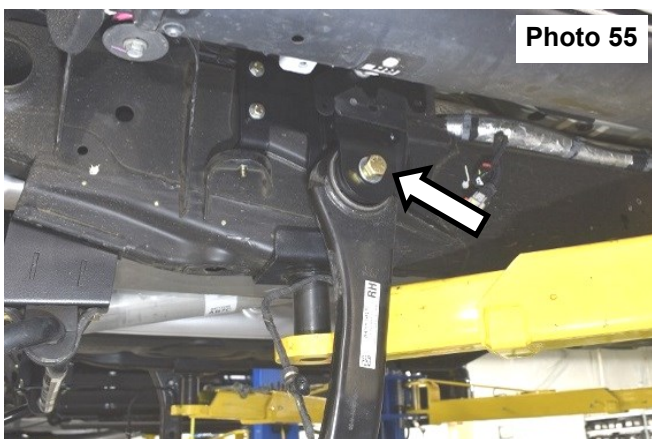
53. Install the trailing arm drop bracket with wiring harness bracket using the stock bolt. **NOTE: The arrow on the wiring harness bracket points toward the front of the vehicle and the tab will capture the hole in the factory pocket.** Do not fully tighten. **See Photo 51.**
54. Install the supplied 1/2" bolts, nuts, and washers in the hole previously drilled in step 36 using a 3/4" socket/wrench. Install the L-bracket with the supplied 3/8" bolts, nuts, and washers using a 9/16" socket/wrench. Tighten the stock bolt using a 21mm socket/wrench (10900BAG3). **See Photo 52.**



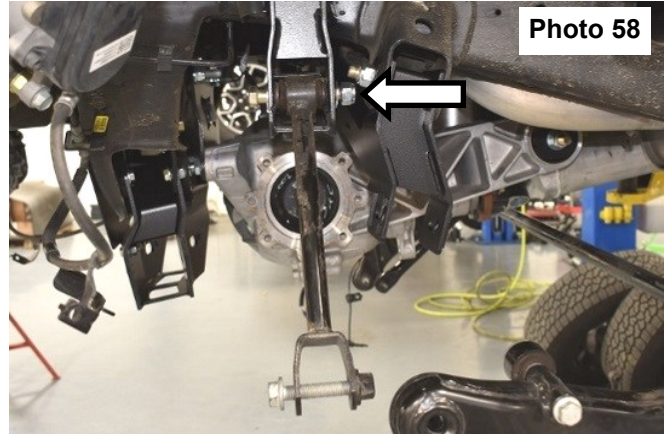
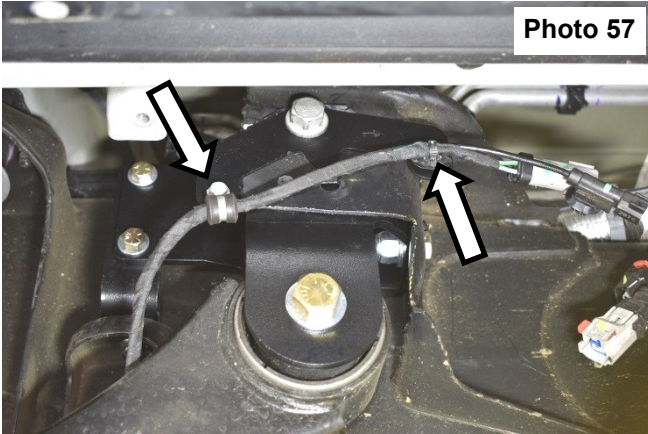
55. Install the sway bar drop bracket with the stock bolts using a 10mm socket/wrench. **See Photo 53.**
56. Install the sway bar to the sway bar drop bracket with the supplied 3/8" bolts, nuts, and washers using a 9/16" socket/wrench (10900BAG4). **See Photo 54.**



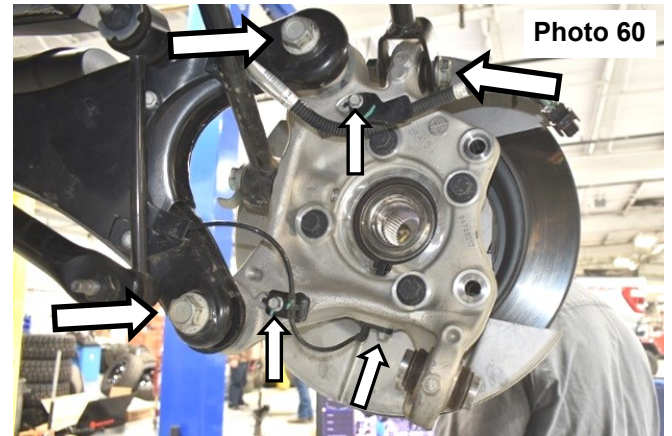
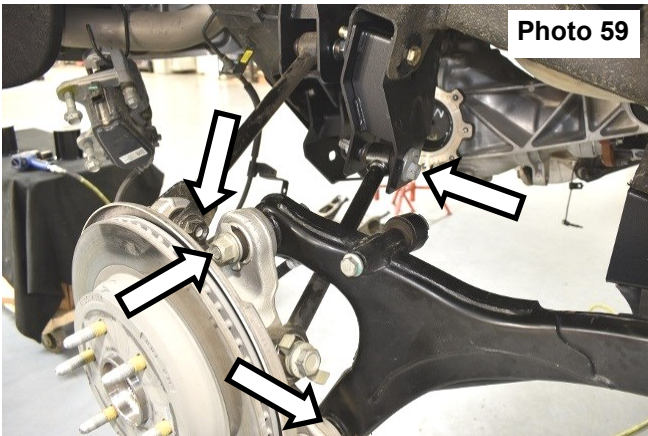
57. Install trailing arms with the supplied 5/8" bolt and washer using a 15/16" socket/wrench (10900BAG3). **See Photo 55.**
58. Support trailing arms with a Jack and attach the sway bar links to the trailing arm with stock bolts using an 18mm socket/wrench. **See Photo 56.**



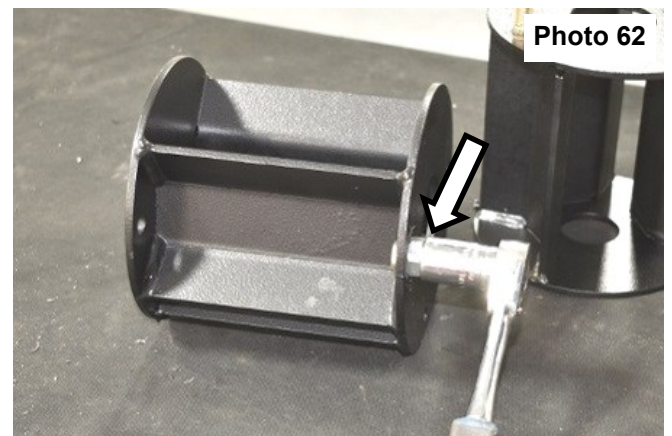
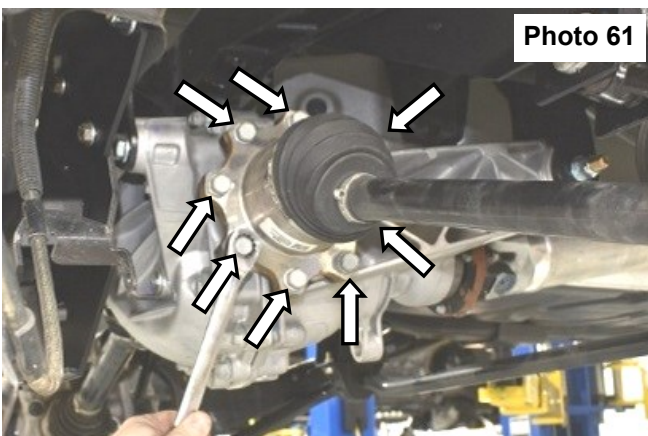
59. Secure ABS and emergency brake wires to bracket on trailing arm with OE hardware with 10mm socket. **See Photo 57.**  
 60. Install the upper control arm with supplied 9/16" bolts, nuts, and washers using 13/16" socket/wrench (10900BAG2). **See Photo 58.**



61. Install the knuckle using stock bolts to trailing arm (24mm) and upper control arm (21mm). Install toe bar into the drop bracket (toe bar may need to be loosened at knuckle) (21mm) **See Photo 59** . Install ABS wires to knuckle (10mm). **See Photo 60.**



62. Install the axle with stock hardware and thread locker using an 18mm socket/wrench. **See Photo 61.**  
 63. Install the 10mm studs into the strut spacers using the 1/2" jam nut, 10mm hex nut and 17mm socket. Place the stud through the hole and then slide the jam nut over the stud. Tighten the 10mm hex nut down to the jam nut and continue to tighten until the stud is flush with the strut spacer. **See Photo 62.**



**NOTE: Do NOT use and impact as this could strip the splines on the stud.**

64. Install the strut spacer onto the strut with the stock hardware using an 18mm socket/wrench. **See Photo 63.**

65. Install the strut with the strut spacer on the truck using a 17mm wrench but do not fully tighten. **See Photo 64.**

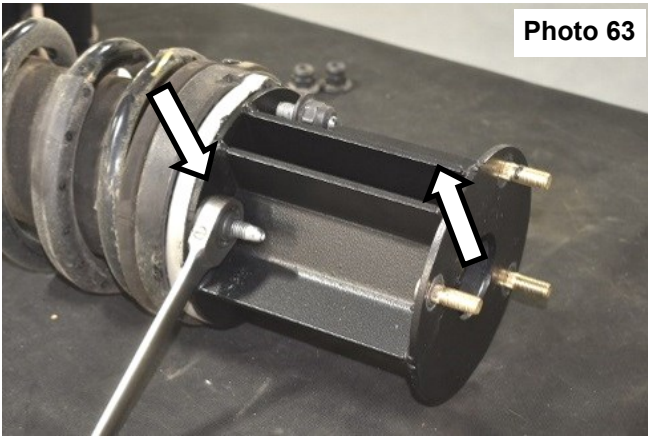


Photo 63

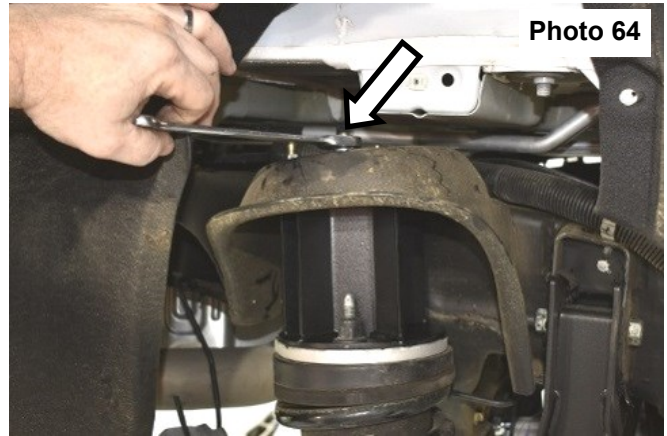


Photo 64

66. Install the lower control arm in the lower control arm bracket with stock hardware using two 1 1/16" wrenches. Make sure the cam bolt tabs are in the slots. **See Photo 65.**

67. Install the lower control arm to the knuckle using stock hardware (24mm) and to the lower strut (21mm). **See Photo 66.**



Photo 65

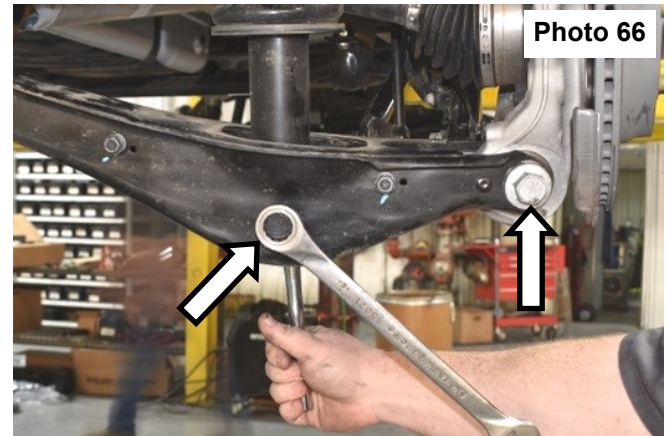


Photo 66

68. Install the brake calipers with the stock hardware using an 18mm socket/wrench. **See Photo 67.**

69. Plug in the emergency brake connector. **See Photo 68.**

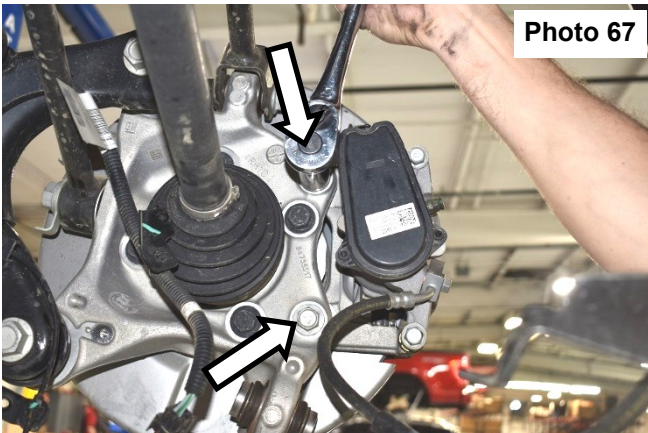


Photo 67

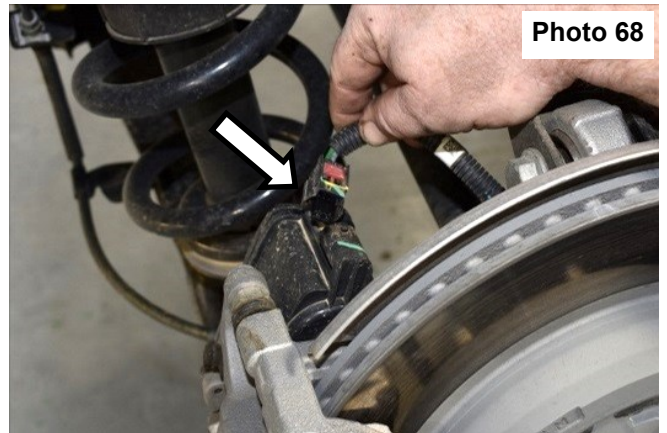
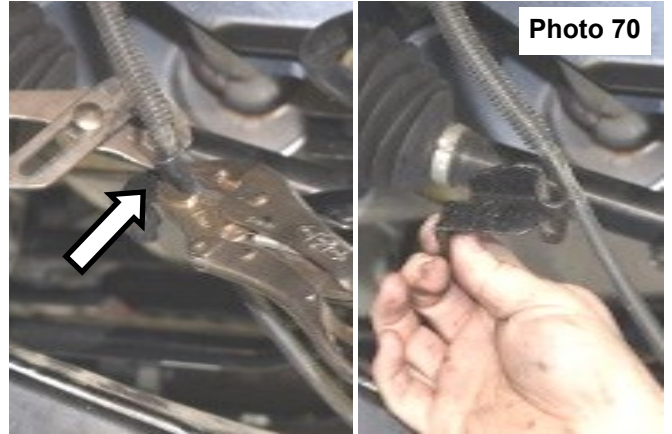
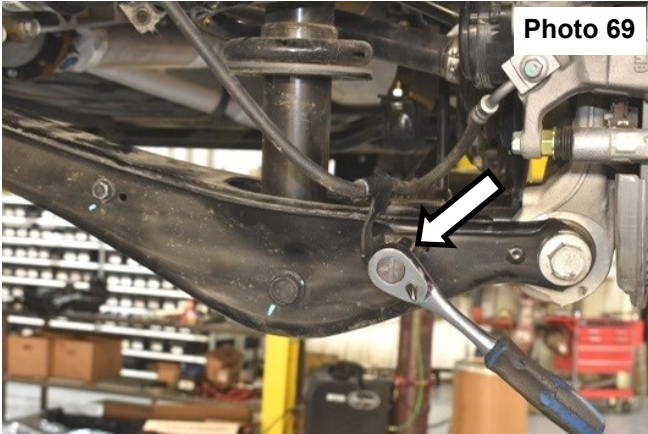


Photo 68

70. Connect brake line to the lower control arm using a 13mm socket/wrench. **See Photo 69.**  
71. The center bracket on the brake line will not be reattached. Remove the bracket from the brake line with pliers. **See Photo 70.**



72. Go back and fully tighten the upper strut using a 15mm wrench and secure the inner fender lining with a T10 Torx bit.  
73. Install wheels and lower the vehicle.  
74. With the vehicle on the ground, fully tighten the following components: trailing arm (24mm), upper control arm (21 & 22mm), Toe arm (21mm), sway bar links (18mm).



## POST INSTALLATION INSTRUCTIONS

1. Check all fasteners for proper torque. Check to ensure for adequate clearance between all rotating, mobile, fixed, and heated members. Verify clearance between exhaust and brake lines, fuel lines, fuel tank, floor boards and wiring harness. Check steering gear for clearance. Test and inspect brake system.
2. Perform steering sweep to ensure front brake hoses have adequate slack and do not contact any rotating, mobile or heated members. Inspect rear brake hoses at full extension for adequate slack. Failure to perform hose check/ replacement may result in component failure.
3. On some vehicles the front lower skirting will need to be trimmed if using certain wheel /tire combinations and with heavy offset wheels. Trim only as needed.
4. Activate four wheel drive system and check front hubs for engagement.
5. Have a qualified alignment center align the vehicle immediately. Realign to factory specifications. The following are the recommended specifications:

Front		Rear	
Caster	$4.1^{\circ} \pm 1.5^{\circ}$	Caster	N/A
Camber	$-0.4^{\circ} \pm 1.0^{\circ}$	Camber	$-0.5^{\circ} \pm 1.0^{\circ}$
Toe In	$0.1^{\circ} \pm 0.2^{\circ}$ Total	Toe In	$0.2^{\circ} \pm 0.2^{\circ}$ Total

6. Perform head light check and adjustment to proper settings.
7. Check and retighten wheels at 50 miles and again at 500 miles.
8. All kit components must be retightened at 500 miles and then every three thousand miles after installation. Periodically check all hardware for tightness.
9. Install "Warning to Driver" decal on sun visor

Note: Installation of larger tires will require speedometer recalibration.



**Thank you for choosing Rough Country for all of your suspension needs.**

By purchasing any item sold by Rough Country, LLC, the buyer expressly warrants that he/she is in compliance with all applicable , State, and Local laws and regulations regarding the purchase, ownership, and use of the item. It shall be the buyers responsibility to comply with all Federal, State and Local laws governing the sales of any items listed, illustrated or sold. The buyer expressly agrees to indemnify and hold harmless Rough Country, LLC for all claims resulting directly or indirectly from the purchase, ownership, or use of the items.



