

ROUGH COUNTRY
SUSPENSION SYSTEMS®



16230BAG3

14-19 TAHOE/YUKON/SUB 6" KIT

Thank you for choosing Rough Country for your suspension needs. We appreciate your business!!

Rough Country recommends a certified technician install this system. In addition to these instructions, professional knowledge of disassemble/reassembly procedures as well as post installation checks must be known. Attempts to install this system without this knowledge and expertise may jeopardize the integrity and/or operating safety of the vehicle.

Please read instructions before beginning installation. Check the kit hardware. Be sure you have all needed parts and know where they go.

PRODUCT USE INFORMATION

⚠ WARNING As a general rule, the taller a vehicle is, the easier it will roll. Seat belts and shoulder harnesses should be worn at all times. Avoid situations where a side rollover may occur. Generally, braking performance and capability are decreased when larger/heavier tires and wheels are used. Take this into consideration while driving. Do not add, alter, or fabricate any factory or after-market parts to increase vehicle height over the intended height of the Rough Country product purchased. Mixing component brands is not recommended.

Rough Country makes no claims regarding lifting devices and excludes any and all implied claims. We will not be responsible for any product that is altered. We will be happy to answer any questions concerning the design, function, and correct use of our products.

This kit is packaged as a leveling kit—raising the front 6" and the rear 5".

Due to differences in manufacturing, dimension and inflated measurements, tire and wheel combinations should be test fit prior to installation.

This kit was developed using a 35x12.50R22 on a factory 22" wheel and a 1/4" wheel spacer. Minor inner fender/air dam trimming and adjustment of the factory step is required with this combination of wheel and tire.

⚠ NOTICE NOTICE TO DEALER AND VEHICLE OWNER

Any vehicle equipped with any Rough Country product should have a "Warning to Driver" decal installed on the inside of the windshield or on the vehicle's dash. The decal should act as a constant reminder for whoever is operating the vehicle of its unique handling characteristics.

INSTALLING DEALER - it is your responsibility to install the warning decal and forward these installation instructions on to the vehicle owner for review. These instructions should be kept in the vehicle for its service life.



16230 MAGNA RIDE-AUTO LEVELING KIT PIC

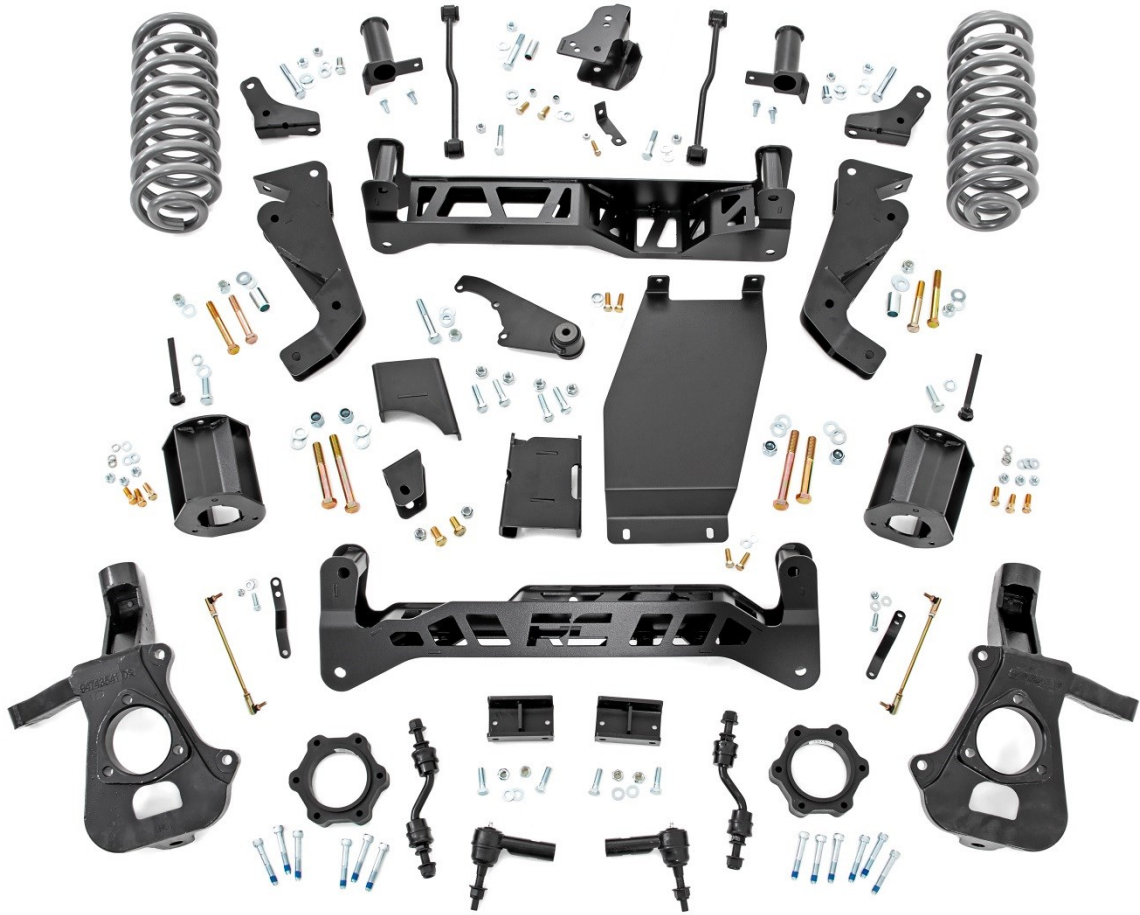

16330 KIT PIC

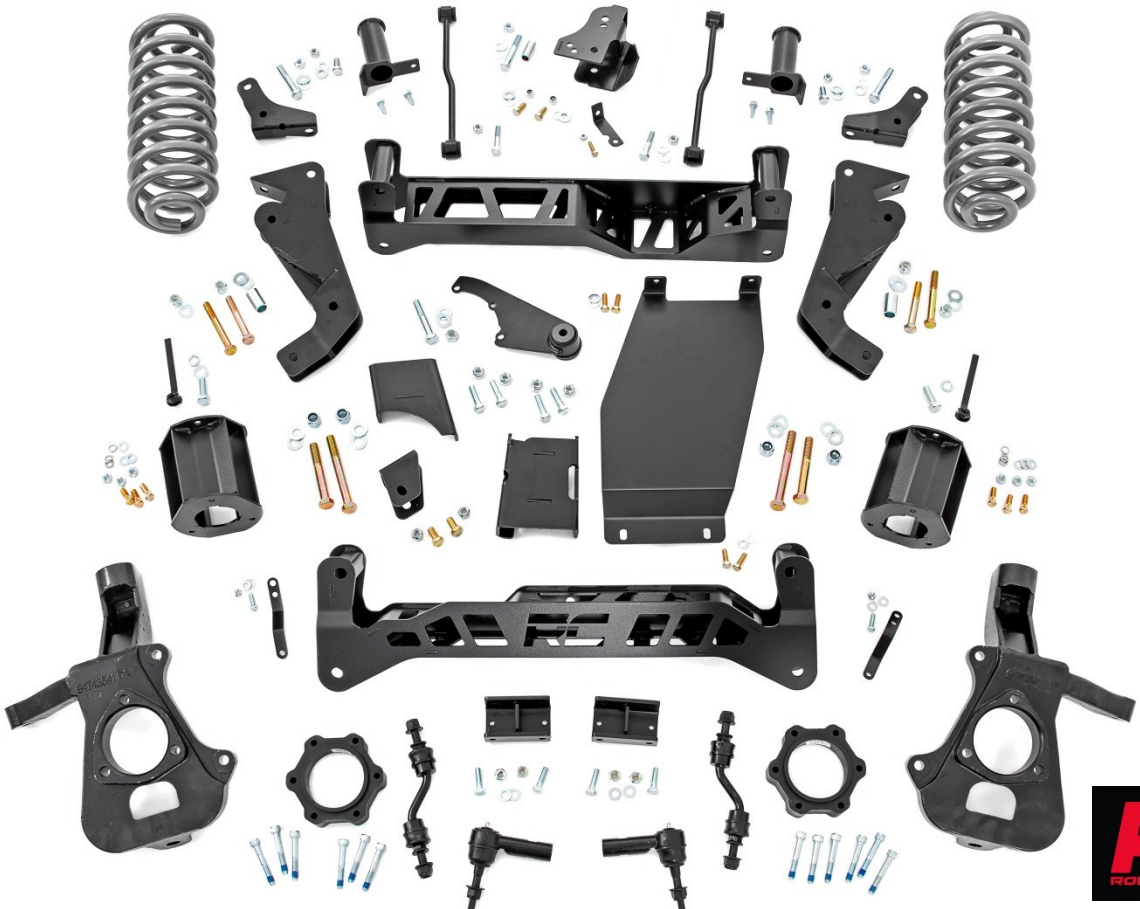

16230 MAGNA RIDE-AUTO LEVELING KIT COMPONENTS

17430Box2

Front Cross Member
Rear Cross Member

17430Box1

Driver Knuckle
Pass Knuckle

16230Box1

16230-1 (Sub Assembly Box)
1229Bag2
1229Bag3
1272Bag3
1290Bag6
10mmStudBag
Frt Crossmember Diff Bracket
Center Diff Bracket
Dr Diff Bracket
Pass Diff Bracket
Skid Plate
Sway Bar Drop Brackets (2)
Sway Links (2)
CV Spacers (2)
Front Brake Line Brackets (2)
Tie Rod Ends (2)

16230Box2

Bump Stops (2)
Driver Rear Shock Bracket
Pass Rear Shock Bracket
Sway Bar Links (2)
Track Bar Bracket
Brake Line Bracket
Rear Control Arm Drop Brackets (2)
Rear Control Arm Flag Nuts (2)
Rear Sensor Links (2)
Strut Spacers (2)
1280Bag1
1287Bag1
16230BAG1

Front Cross Member
5/8" X 4 1/2" Bolt (2)
5/8" Nuts (2)
5/8" Flat Washers (4)

Rear Cross Member
5/8" x 5 1/2" Bolt (2)
5/8" Lock Nuts (2)
5/8" Flat Washers (4)

Front CV Axle Spacers
10mm x 65mm SHCS Bolt (12)

Driver Side Diff. Drop Bracket
12mm x 35mm Bolt (2)
12mm Flange Nut (2)
12mm Washer (2)

Pas Side Differential Brkt
12mm x 45mm Bolt (2)
12mm Flange Nut (2)
12mm Washer (2)

Lower Strut to Ctrl Arm Mt
10mm x 55mm Bolt (4)
10mm Lock Nuts (4)
10mm Washers (8)

Sway Bar Bracket
10mm x 35mm Bolt (4)
10mm Lock Nuts (4)
10mm Lock Washer (4)
10mm Washers (8)

Frt & Rr Brake Line Brackets
5/16" x 3/4" Bolt (4)
5/16" Nylon Lock Nut (4)
5/16" Washer (8)

Skid Plate Installation
3/8" x 1" Bolt (4)
3/8" Lock Washer (4)
3/8" Flat Washer (4)

Rear Spring Spacer
3/8" x 3 3/4" Bolt (2)
3/8" Flangelock
Spring Spacer Washers

Rear Shock Brackets
5/8" x 1.5" Bolt (2)
5/8" Lock Nut (2)
5/8" Washers(4)

14mm x 75mm Bolts (2)
14mm Nylocks (2)
14mm Washers (4)

Rear Sway Bar Links
12mm x 65mm Bolts (2)
12mm Flangelocks (2)
12mm Washers (2)

Sleeves (4)
Brake Line Bracket
5/16" x 1 1/4" Bolt
5/16" Flange Lock Nut

Track Bar Bracket
Sleeve .562 x .750 x 1.75
9/16" x 3 1/2" Bolt
9/16" Lock Nut

9/16" Washer (2)
7/16" x 1" Bolt (2)
7/16" Nylock (2)
7/16" Washers (4)

Rear Bump Stops
3/8" x 1" Self Tapping Bolt (4)

Rear Coil Spacers
3/8" x 2.25" Bolts (2)
3/8" Flange Nuts (2)

Rear Control Arm Drop Brackets
Sleeves(2)
9/16" x 4" Bolts (2)
9/16" x 4.5" Bolts (2)

9/16" Flat Washers (9)
9/16" Nylock Nuts (4)
14mm x 40mm Bolts (2)
14mm Lock Washers (2)

9404

Rear Coil Springs (2)

Torque Specs:

Size	Grade 5	Grade 8
5/16"	15 ft/lbs	20 ft/lbs
3/8"	30 ft/lbs	35 ft/lbs
7/16"	45 ft/lbs	60 ft/lbs
1/2"	65 ft/lbs	90 ft/lbs
9/16"	95 ft/lbs	130 ft/lbs
5/8"	135 ft/lbs	175 ft/lbs
3/4"	185 ft/lbs	280 ft/lbs
	Class 8.8	Class 10.9
6MM	5 ft/lbs	9 ft/lbs
8MM	18ft/lbs	23 ft/lbs
10MM	32ft/lbs	45ft/lbs
12MM	55ft/lbs	75ft/lbs
14MM	85ft/lbs	120ft/lbs
16MM	130ft/lbs	165ft/lbs
18MM	170ft/lbs	240ft/lbs

Tools Needed:

Floor Jack /Jack Stands
8mm Allen Socket
10mm socket /wrench
11mm socket /wrench
13 mm socket/wrench
15mm socket / wrench
17mm socket/wrench
18mm socket /wrench
21mm socket /wrench
22mm socket /wrench
24mm socket /wrench
19mm socket /wrench
35mm socket
9/16 socket /wrench
Torsion bar Tool
Reciprocating Saw
Drill
11/16" Drill Bit
Hand Grinder
Thread Locker
Torque Wrench



16330 KIT COMPONENTS

17430Box2

Front Cross Member
Rear Cross Member

17430Box1

Driver Knuckle
Pass Knuckle

16230Box1

16230-1 (Sub Assembly Box)
1229Bag2
1229Bag3
1272Bag3
1290Bag6
10mmStudBag
Frt Crossmember Diff Bracket
Center Diff Bracket
Dr Diff Bracket
Pass Diff Bracket
Skid Plate
Sway Bar Drop Brackets (2)
Sway Links (2)
CV Spacers (2)
Front Brake Line Brackets (2)
Tie Rod Ends (2)

16330Box1

Bump Stops (2)
Driver Rear Shock Bracket
Pass Rear Shock Bracket
Sway Bar Links (2)
Track Bar Bracket
Brake Line Bracket
Rear Control Arm Drop Brackets (2)
Rear Control Arm Flag Nuts (2)
Strut Spacers (2)
1280Bag1
1287Bag1
16230BAG1

9404

Rear Coil Springs (2)

Front Cross Member
5/8" X 4 1/2" Bolt (2)
5/8" Nuts (2)
5/8" Flat Washers (4)

Rear Cross Member
5/8" x 5 1/2" Bolt (2)
5/8" Lock Nuts (2)
5/8" Flat Washers (4)

Front CV Axle Spacers
10mm x 65mm SHCS Bolt (12)

Driver Side Diff. Drop Bracket
12mm x 35mm Bolt (2)
12mm Flange Nut (2)
12mm Washer (2)

Pas Side Differential Brkt
12mm x 45mm Bolt (2)
12mm Flange Nut (2)
12mm Washer (2)

Lower Strut to Ctrl Arm Mt
10mm x 55mm Bolt (4)
10mm Lock Nuts (4)
10mm Washers (8)

Sway Bar Bracket
10mm x 35mm Bolt (4)
10mm Lock Nuts (4)
10mm Lock Washer (4)
10mm Washers (8)

Frt & Rr Brake Line Brackets
5/16" x 3/4" Bolt (4)
5/16" Nylon Lock Nut (4)
5/16" Washer (8)

Skid Plate Installation
3/8" x 1" Bolt (4)
3/8" Lock Washer (4)
3/8" Flat Washer (4)

Rear Spring Spacer
3/8" x 3 3/4" Bolt (2)
3/8" Flangelock
Spring Spacer Washers

Rear Shock Brackets
5/8" x 1.5" Bolt (2)
5/8" Lock Nut (2)
5/8" Washers(4)

14mm x 75mm Bolts (2)
14mm Nylocks (2)
14mm Washers (4)

Rear Sway Bar Links
12mm x 65mm Bolts (2)
12mm Flangelocks (2)
12mm Washers (2)

Sleeves (4)
Brake Line Bracket
5/16" x 1 1/4" Bolt
5/16" Flange Lock Nut

Track Bar Bracket
Sleeve .562 x .750 x 1.75
9/16" x 3 1/2" Bolt
9/16" Lock Nut

9/16" Washer (2)
7/16" x 1" Bolt (2)
7/16" Nylock (2)
7/16" Washers (4)

Rear Bump Stops
3/8" x 1" Self Tapping Bolt (4)

Rear Coil Spacers
3/8" x 2.25" Bolts (2)
3/8" Flange Nuts (2)

Rear Control Arm Drop Brackets
Sleeves(2)
9/16" x 4" Bolts (2)
9/16" x 4.5" Bolts (2)
9/16" Flat Washers (9)
9/16" Nylock Nuts (4)
14mm x 40mm Bolts (2)
14mm Lock Washers (2)

Torque Specs:

Size	Grade 5	Grade 8
5/16"	15 ft/lbs	20 ft/lbs
3/8"	30 ft/lbs	35 ft/lbs
7/16"	45 ft/lbs	60 ft/lbs
1/2"	65 ft/lbs	90 ft/lbs
9/16"	95 ft/lbs	130 ft/lbs
5/8"	135 ft/lbs	175 ft/lbs
3/4"	185 ft/lbs	280 ft/lbs
	Class 8.8	Class 10.9
6MM	5 ft/lbs	9 ft/lbs
8MM	18ft/lbs	23 ft/lbs
10MM	32ft/lbs	45ft/lbs
12MM	55ft/lbs	75ft/lbs
14MM	85ft/lbs	120ft/lbs
16MM	130ft/lbs	165ft/lbs
18MM	170ft/lbs	240ft/lbs

Tools Needed:

Floor Jack /Jack Stands
8mm Allen Socket
10mm socket /wrench
11mm socket /wrench
13 mm socket/wrench
15mm socket / wrench
17mm socket/wrench
18mm socket /wrench
21mm socket /wrench
22mm socket /wrench
24mm socket /wrench
19mm socket /wrench
35mm socket
9/16 socket /wrench
Torsion bar Tool
Reciprocating Saw
Drill
11/16" Drill Bit
Hand Grinder
Thread Locker



FRONT INSTALLATION

1. Park the vehicle on a level surface and chock the rear wheels. Raise the hood and disconnect the battery using a 10mm socket. Lock the steering wheel in the straight position.
2. Jack up the front of the vehicle. Place jack stands under the frame rails and lower onto jack stands letting the front suspension hang.
3. Remove the tires and wheels. Remove the 6 bolts holding the factory skid plate using a 15mm socket. Unplug the two connectors going to the electric power steering wiring harness behind the front skid plate. **See Photo 1.**
4. Remove and unplug the ABS sensor wire from the frame as shown in **Photo 2.**



5. Remove the sensor wire from the plastic clip. Remove the brake line bracket from the control arm using a 10mm wrench. **See Photo 3.** Next remove the bracket line bracket from the control arm pocket with a 13mm wrench.
6. Using a 21mm wrench, remove the tie-rod nut as shown in **Photo 4.** Strike the front of the mount to dislodge the tie rod end. Remove from the knuckle.



7. Remove the brake caliper using a 18mm socket. Hang the caliper out of the way and remove the rotor using a 30 torx socket. **See Photo 5.**
8. Use a 10mm socket to remove the ABS bracket from the top side of the knuckle.
9. Remove the dust cap and then remove the axle nut using a 35mm socket.

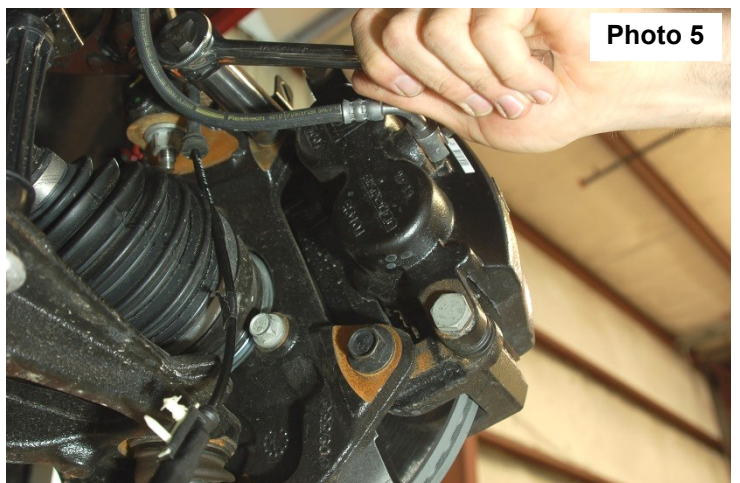

10. Remove the upper ball joint using a 18mm socket and separate using a hammer and striking the knuckle on the side as shown in **Photo 6**.
11. Remove the lower ball joint using a 24mm socket and separate with a hammer as shown in **Photo 7**. Next remove the knuckle from the truck.

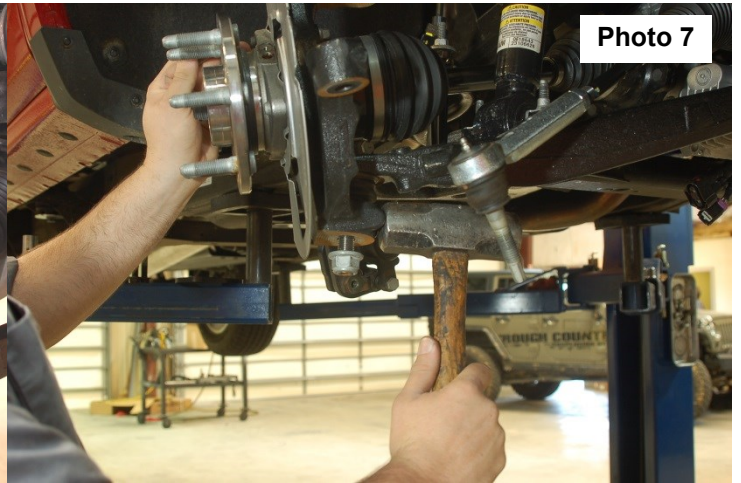
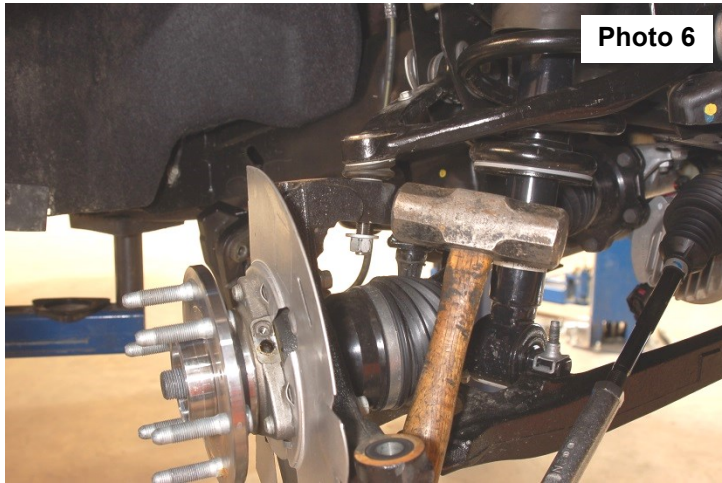

12. Using a 15mm wrench and socket remove the sway bar links from the truck. **See Photo 8**.
13. Remove the lower strut bolts using a 15mm socket as shown in **Photo 9** and remove the upper strut nuts using a 18mm wrench. Remove the strut from the truck.

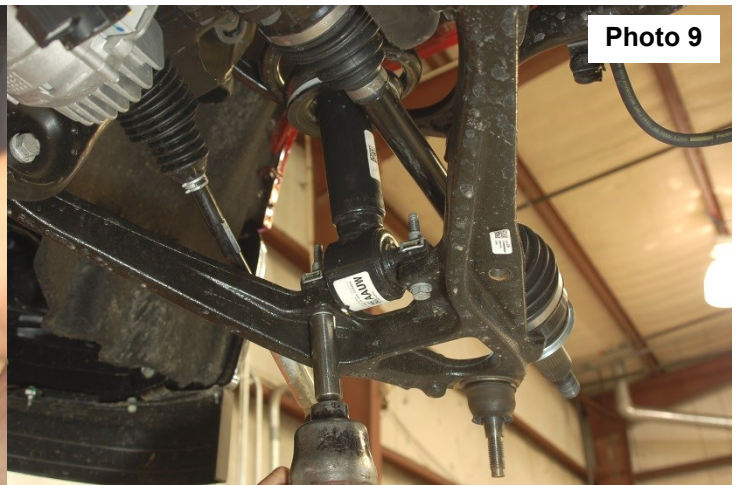
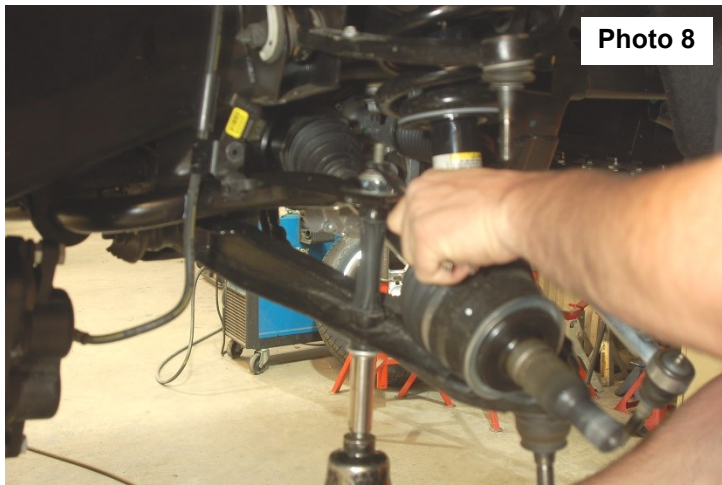

14. Remove CV axle bolts using a 15mm socket. **See Photo 10**.
15. Using a 10mm socket remove the sway bar from the bottom of the frame. **See Photo 11**.

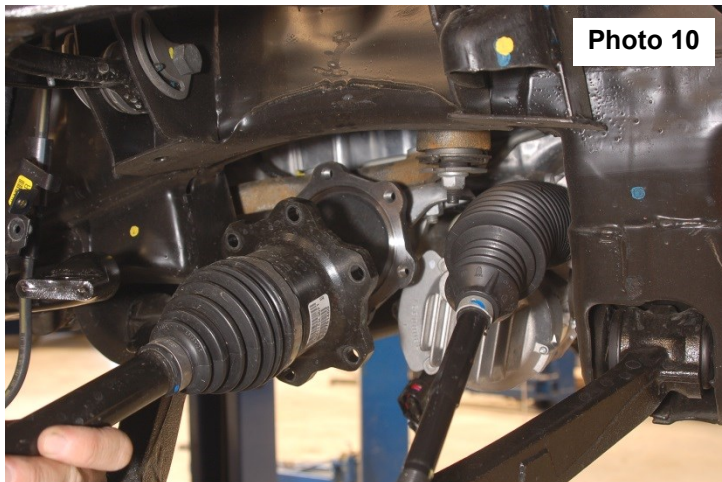

16. Remove the lower control arm using a 18mm wrench and a 24mm socket. **See Photo 12.**
 17. Using a 18mm wrench and socket remove the factory lower rear cross-member. **See Photo 13.**

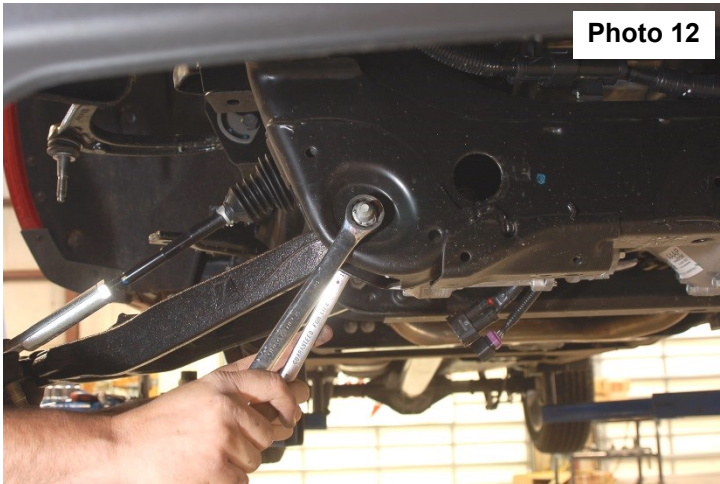

Photo 12

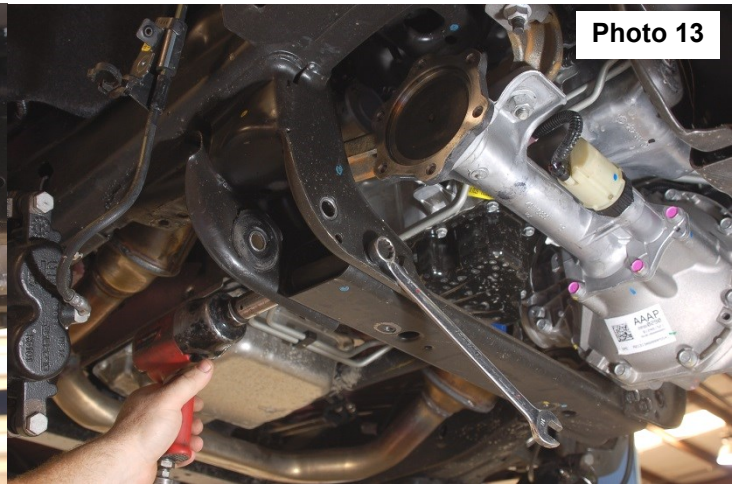

Photo 13

18. Using a 11mm socket remove the driveshaft from the front diff . **See Photo 14.** Unplug the actuator wire from diff, remove wire loom from diff, and remove vent tube from diff.
 19. Make sure the steering wheel is straight, mark the steering shaft and pinion shaft as shown in **Photo 15.** Use a 11mm socket to remove the connecting bolt. With a jack support the rack and pinion, using a 24mm and 18mm socket remove the bolts from the rack and pinion mounts. Carefully lower the rack and pinion down making sure no wires are in harms way. Now you can remove the diff, use a 18mm and 21mm socket remove the bolts from diff. lower diff from truck.



Photo 14

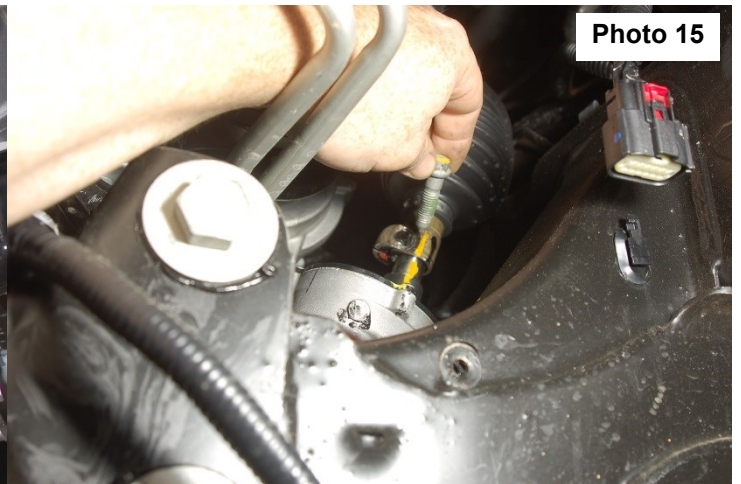

Photo 15

20. Mark the front and rear sides of the driver and passenger side rear control arm pocket, measure 3 3/8" from the end and cut off the factory crossmember mount. **See Photo 16 & 17.**

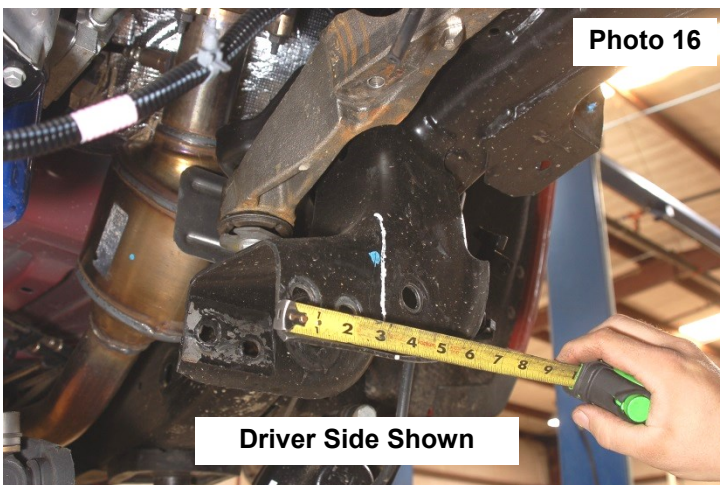

Photo 16

Driver Side Shown



Photo 17

Passenger Side Shown

21. On the driver and passenger side rear control arm pocket cut the front lip off flush with the pocket 1.0" past the control arm hole . Sand edges and paint to prevent rust. **See Photo 18.**
22. On the passenger side of the diff cut the front ear off using a saw-zall or cut off wheel. Cut flush with the flat areas on the diff and grind smooth. **See Photo 19.**

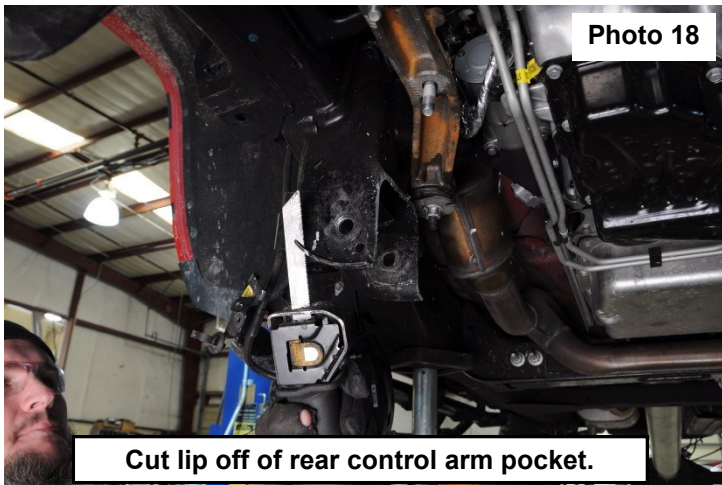

Photo 18
Cut lip off of rear control arm pocket.

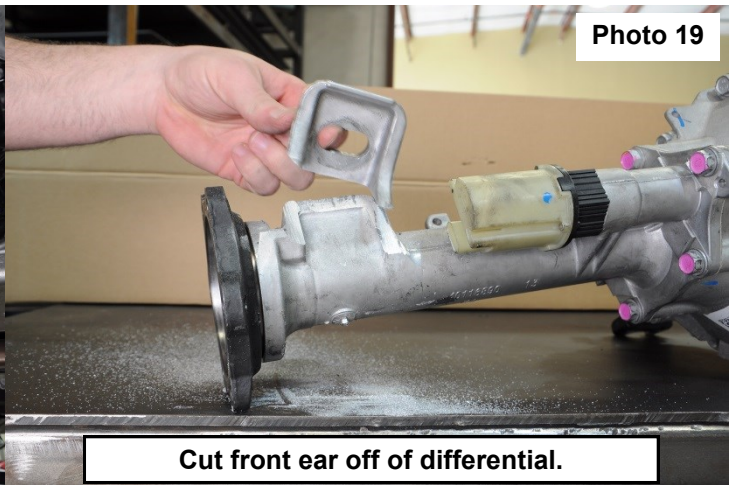

Photo 19
Cut front ear off of differential.

23. Re-install the rack and pinion with factory hardware Torque the drivers side to 165 ft-lbs. using a 24mm and Torque the passengers side to 75 ft-lbs. 18mm sockets. Make sure to align the marks on the steering shaft. Install the passenger side diff drop bracket with the supplied 12mm flange locks on the factory studs. Tighten with a 18mm socket . **See Photo 20. Torque to 75 ft-lbs.**
24. Install the driver side diff drop bracket with the factory bolts and Torque to 75 ft-lbs. with a 18mm socket. **See Photo 21.**
25. Install the diff using the supplied 12mm bolts and flange nuts on the driver side and 12mm bolts with stock nuts on the passenger side. Do not tighten at this time.

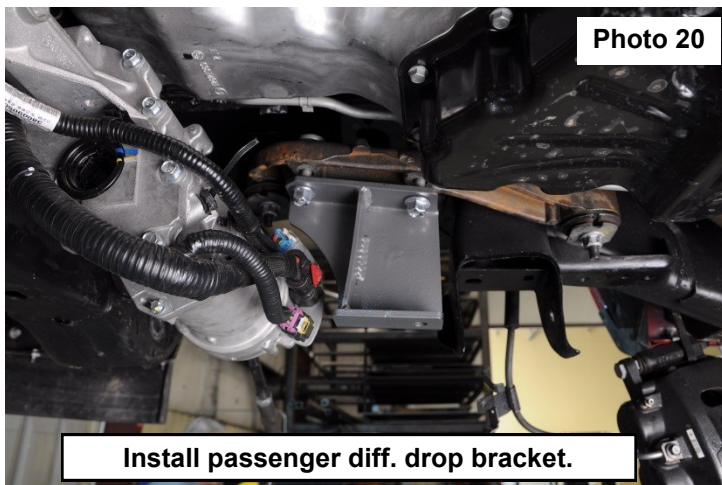

Photo 20
Install passenger diff. drop bracket.

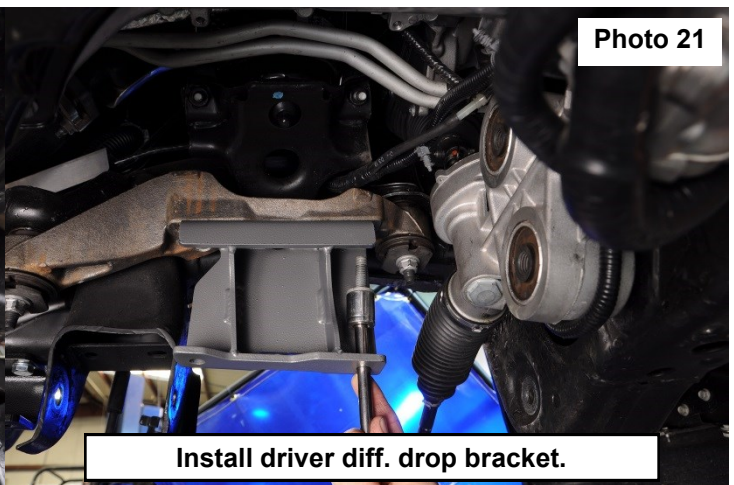
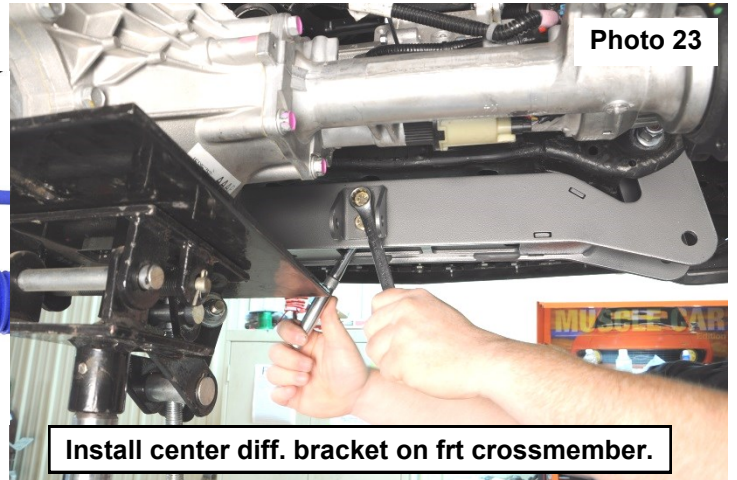

Photo 21
Install driver diff. drop bracket.

26. Install front crossmember using new 5/8" x 4.5" bolts, washer, and nuts. Hand tighten. **See Photo 22.**
27. Install center diff drop mounting bracket using the supplied 1/2" x 1.0" bolts and nuts to the front crossmember. Torque to 90ft-lbs. using a 3/4" socket and wrench. **See Photo 23.**



Install front crossmember.



Install center diff. bracket on frt crossmember.

28. Remove the 3 bolts in the diff using a 15mm socket. Shown in **Photo 24.** Install the center diff bracket onto the diff with the 3 factory bolts removed. Install the supplied 14mm x 85mm bolt, washers, and lock nut, in the front center bracket. **See Photo 24.** Torque factory hardware in diff to 32 ft-lbs. using 15mm socket, Torque 14mm hardware in front crossmember bracket to 85ft-lbs. using a 22mm Socket and wrench.
29. After installing the diff, torque all diff bolts to 55 ft-lbs. **See Photo 25.** Make sure the diff on the passenger side clears the rack and pinion and no wires are pinched between the diff and the rack. Plug in the vent tube extension and the 4x4 actuator.

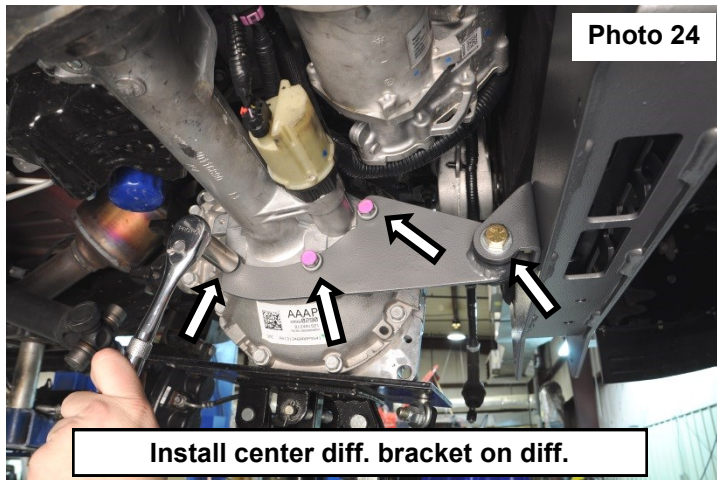

Install center diff. bracket on diff.

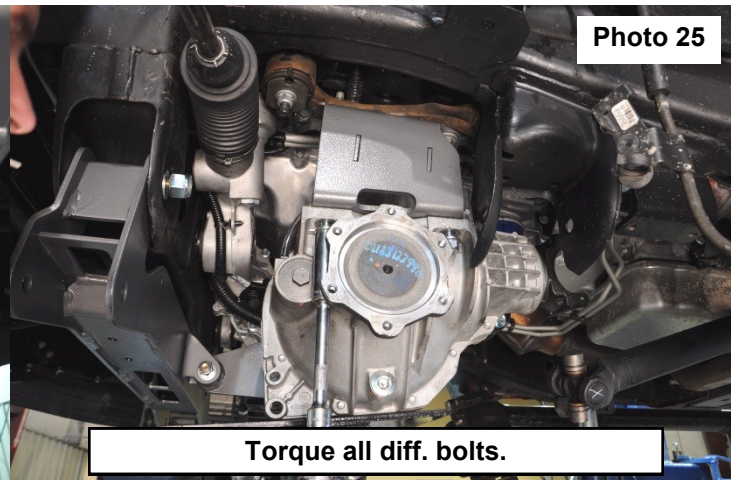

Torque all diff. bolts.

30. Install the driveshaft using stock hardware and a 11mm wrench to tighten. **See Photo 26.** Torque to 19 ft-lbs.
31. Install the rear crossmember with the supplied 5/8" x 5.5" bolts. Hand tighten.
32. Install the factory lower control arm with stock hardware. Hand tighten. Now tighten the 5/8" bolts that secures the crossmembers to the frame with a 24mm wrench. **See Photo 27.** Torque to 175ft-lbs.

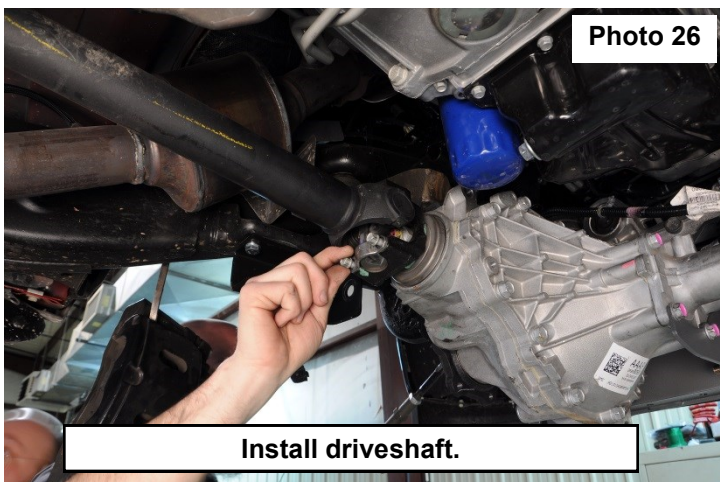

Install driveshaft.

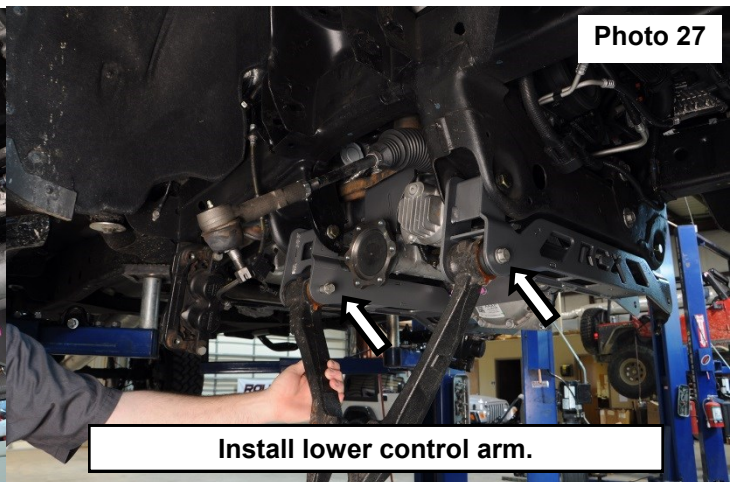

Install lower control arm.

33. Install sway-bar drop bracket using 10mm x 35 mm bolts and washers. Torque to 35ft-lbs. using 17mm wrench. **See Photo 28.**
34. Install sway-bar using stock bolt with new 10mm nuts. **See Photo 29.** Torque to 35 ft-lbs. using a 10mm socket and 17mm wrench.

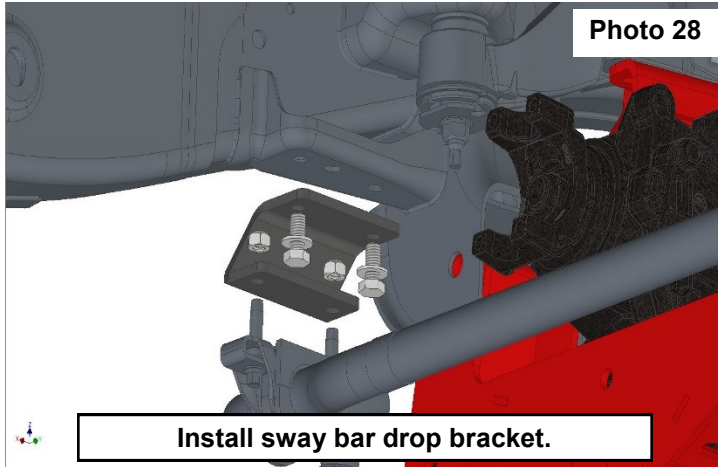

Install sway bar drop bracket.

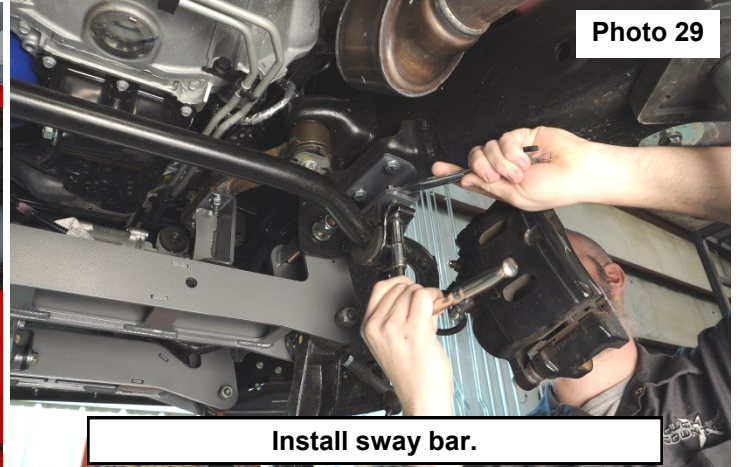

Install sway bar.

35. Install the CV spacer as shown in **Photo 30** between the axle shaft and the differential. Secure with the supplied 10mm x 65mm allen head bolts. Torque to 35 ft-lbs. with a 8mm allen socket.
36. Install the supplied sway bar link using the supplied nuts. **Do Not use an Impact!!!** Torque to 90ft-lbs using a 19mm wrench and 21mm socket. **Do Not use an Impact!!! See photo 31.**

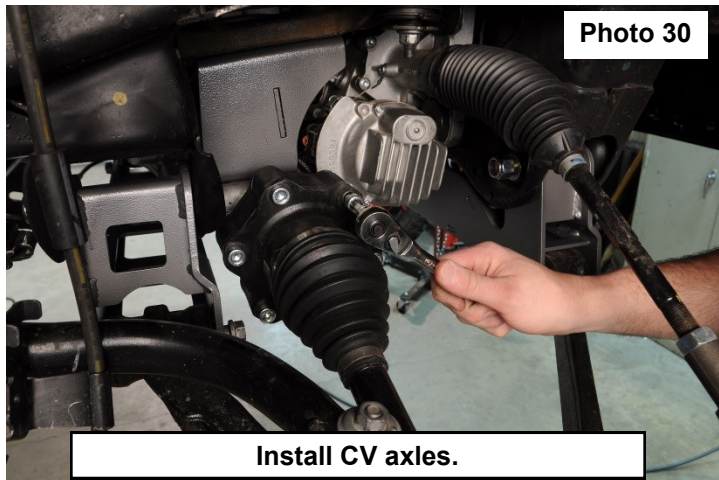

Install CV axles.



Install supplied sway bar links.

37. On the factory knuckles, remove the bearing assembly using a 15mm wrench. Next the brake shroud must be trimmed to allow the caliper to install on the new knuckle. Mark the dust shroud as shown in **Photo 32** and trim. Install the factory bearing and dust shroud into the new supplied knuckle. Tighten with a 15mm wrench. **See Photo 33.** Torque to 126 ft-lbs.

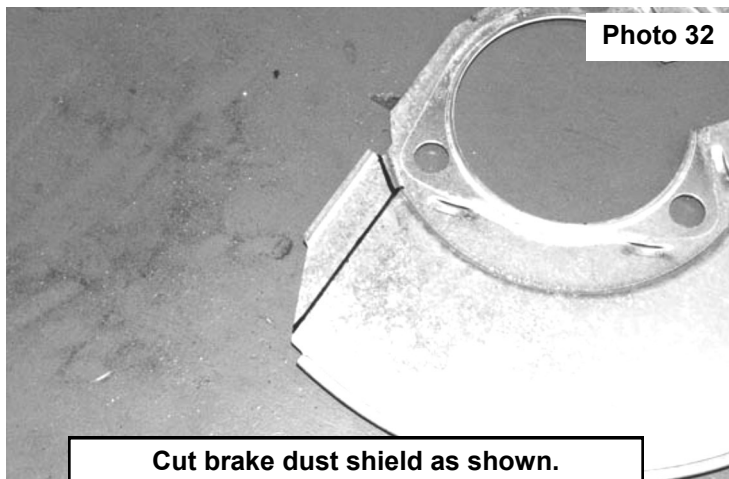

Cut brake dust shield as shown.

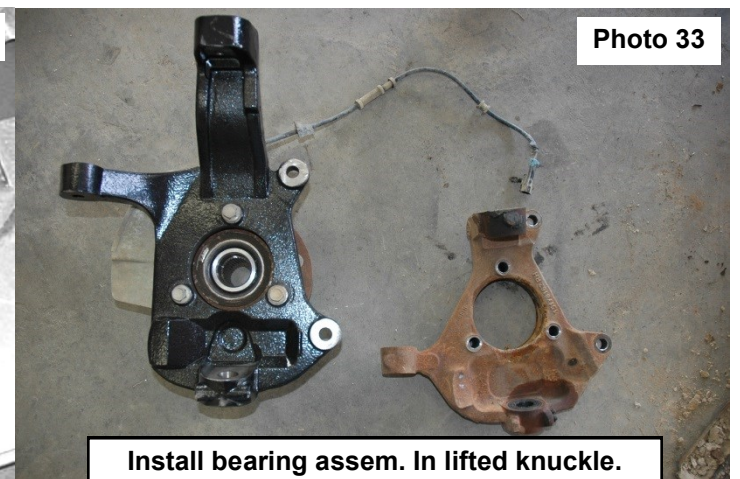

Install bearing assem. In lifted knuckle.

38. Install brake line drop bracket to the frame using stock hardware. Next secure factory brake line mount to the new drop bracket using the supplied 5/16" x 1" bolts, washers, and nuts. **See Photo 34.** Use a 13mm wrench and socket to tighten. **Torque to 35ft-lbs.**
39. Press in the 10mm studs into the strut spacer. Install strut spacer on to strut using stock hardware Torque to 45 ft-lbs. using a 18mm socket.
40. Install strut into truck using the supplied 10mm nuts and lock washers. Torque to 35ft-lbs. Use a 9/16" socket. **See Photo 35.**

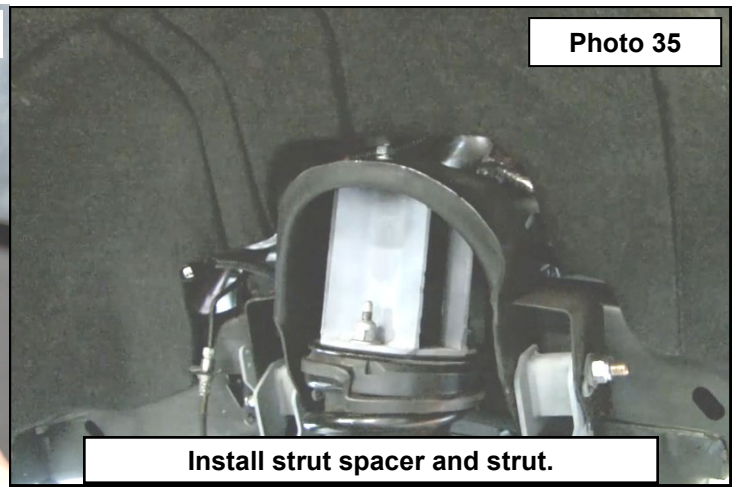
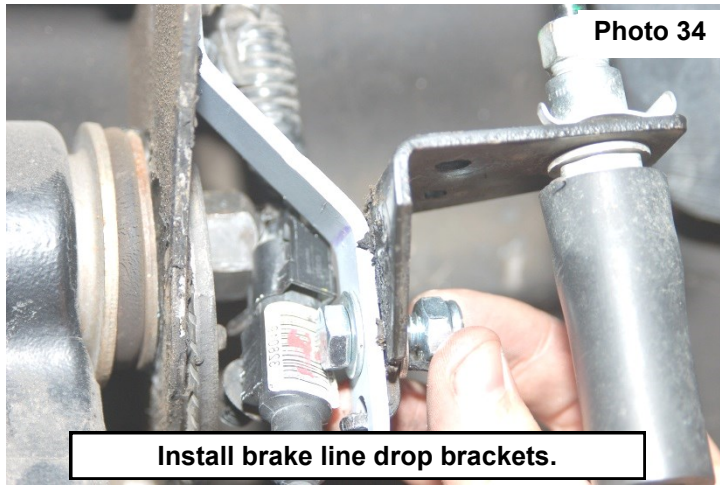

41. Use stock hardware for lower strut mount and use a 15mm wrench to tighten lower strut bolts. Torque to 45 ft-lbs.
42. Remove the ABS wire from the brake line clip and remove the brake line from the bracket using a flat head screw driver and trim as shown in **Photo 36.** Reinstall the modified bracket on the stock control arm with the stock hardware and reinstall the ABS wire in the clip. Torque to 5 ft-lbs.
43. Install knuckles using stock hardware. Torque the lower ball joint to 38 ft-lbs. use a 24mm socket. Torque the upper ball joint to 40 ft-lbs. using a 18mm socket. **Torque the axle nut to 156 ft-lbs. using a 35mm socket. See Photo 37.**

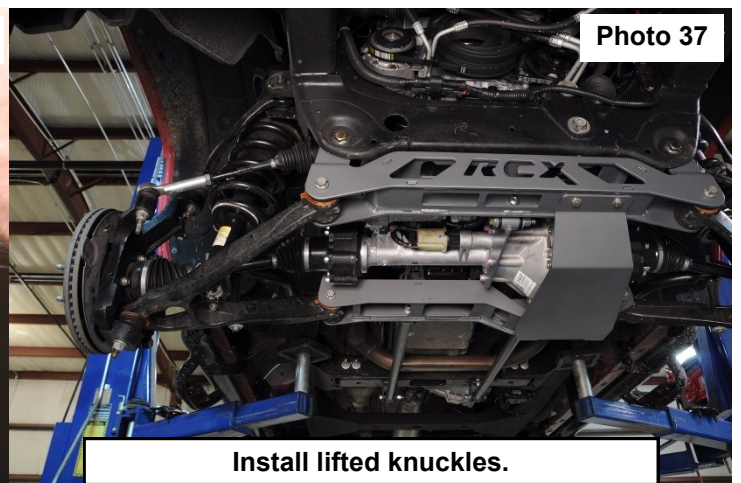
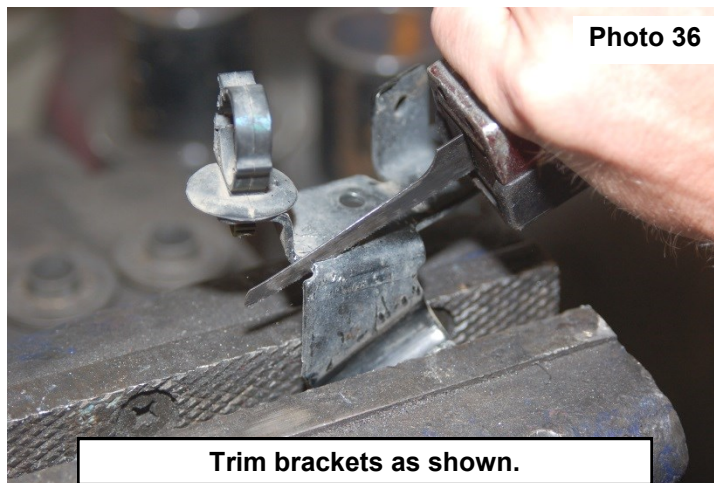

44. Install the factory tie rod end jam nut. Install the supplied tie rod ends on the tie rods and attach to the knuckle using the supplied hardware. Tighten using a 21mm wrench.
45. Install rotor and the stock hardware Torque to 5 ft-lbs. using a 30mm torx. Install the brake caliper Torque to 130 ft-lbs. using a 18mm socket.
46. Install skid plates using supplied 3/8" x 1.25" bolts and washers. **See Photo 37.** Torque to 35ft-lbs. use a 9/16 socket to tighten all bolts.
47. Install the wheels and tires, then jack up the truck and remove the jack stands. Lower truck on ground and Torque the upper control arm to 85 ft-lbs. using 21mm wrench and socket and Torque the lower control arm bolts to 196 ft-lbs. use a 18mm wrench and 24mm socket.

Due to tire manufacturer variances and/or other wheel and tire combinations, modification to the upper control arm may be necessary to prevent rubbing. Using a rotary sander, lightly sand the front lip of the factory upper control arm until there is no contact with the wheel and/or tire throughout the full turning radius. **See Photo 38.**

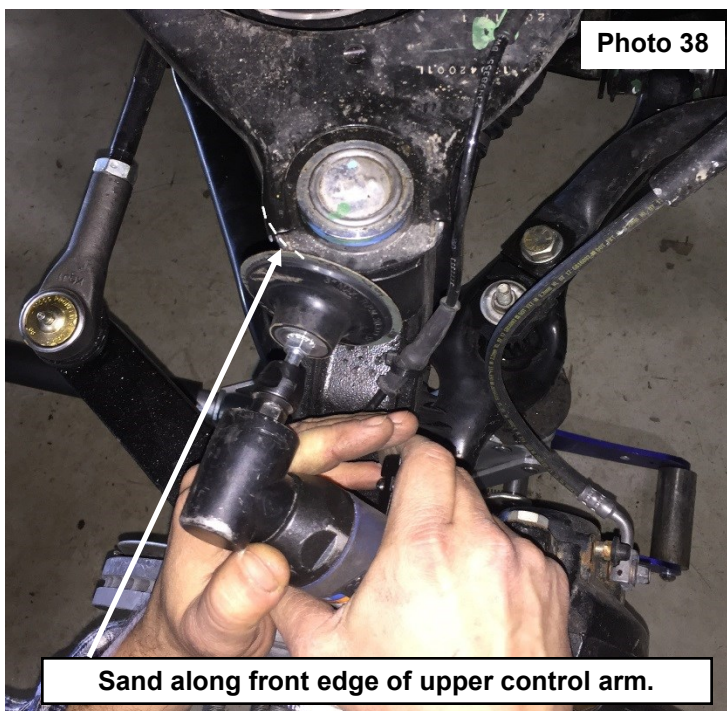

REAR INSTALLATION INSTRUCTIONS

1. Chock the front wheels and jack up the rear of the vehicle. Support the vehicle with jack stands.
2. Remove the tires/wheels using 7/8" deep well socket.
3. Lightly support the axle with a floor jack.
4. Using a flat head screwdriver, remove the e-brake line from the track rod by removing the clip as shown in **Photo 1**.
5. Remove the track rod from the axle as shown in **Photo 2** using a 21mm socket/wrench.

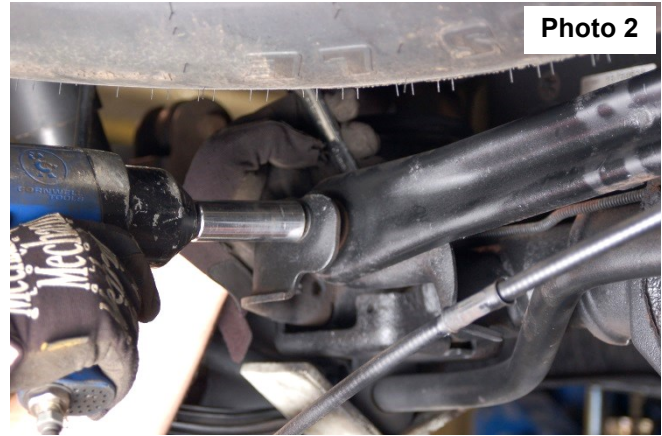
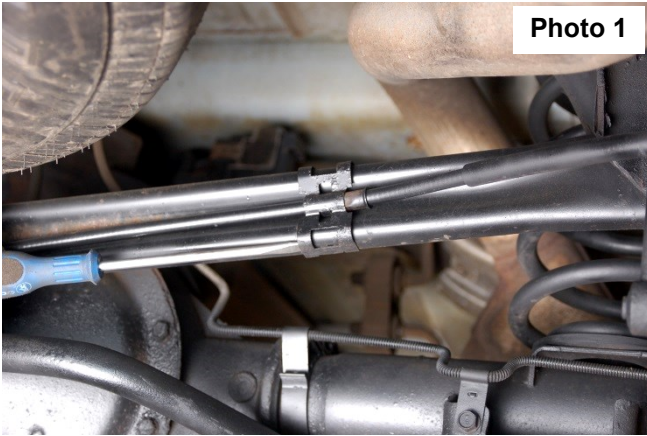

6. Remove the bolt securing the brake line bracket using a 13mm socket as shown in **Photo 3**. Retain hardware for reuse.
7. Remove the sway bar links from the axle and the frame using a 18mm wrench as shown in **Photo 4**. Retain the upper frame mount hardware for reuse.

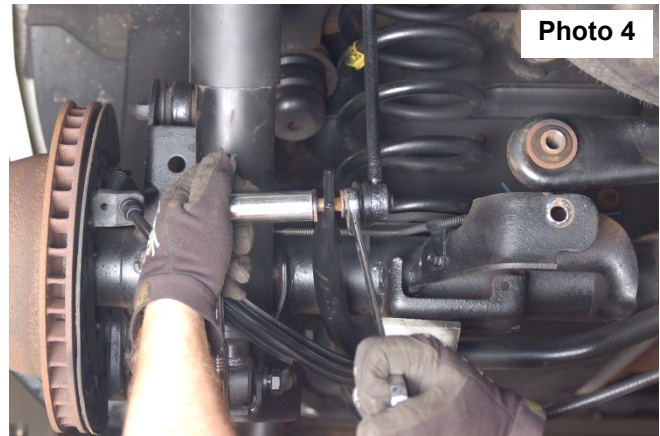

8. Remove the lower shock from the axle using a 21mm wrench/socket leaving the upper part of the shock attached to the frame. Retain the hardware for reuse.
9. Using a 13mm socket, remove the e-brake line bracket from the lower control arm axle mount. Retain for reuse. **See Photo 5.**
10. Remove the upper and lower control arms using 21mm wrenches/sockets. Retain hardware for reuse.
11. Lower the axle with the floor jack and remove the coil springs.

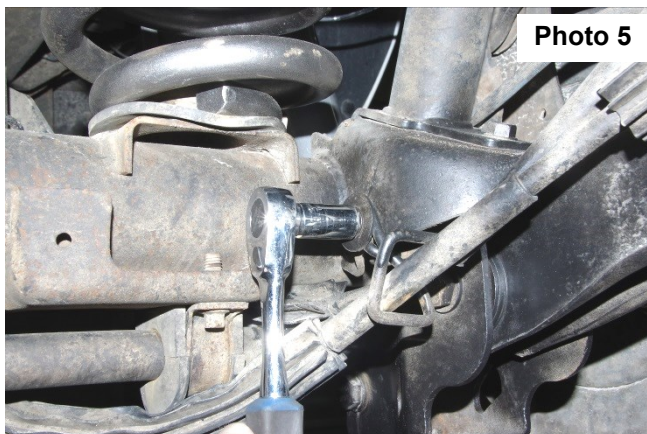

12. Install the supplied control arm drop bracket into the factory control arm pockets on the frame. Use the factory hardware in the lower mount to hold the bracket. **Do Not Tighten. See Photo 6.**
13. Install the supplied sleeve from 1287BOX1, into the upper control arm mount. **See Photo 7.**

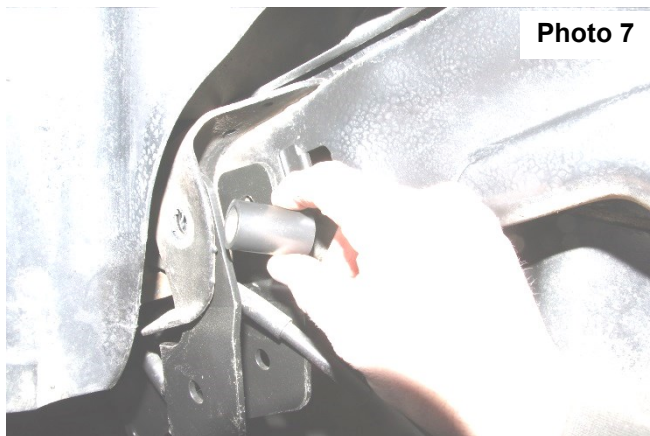
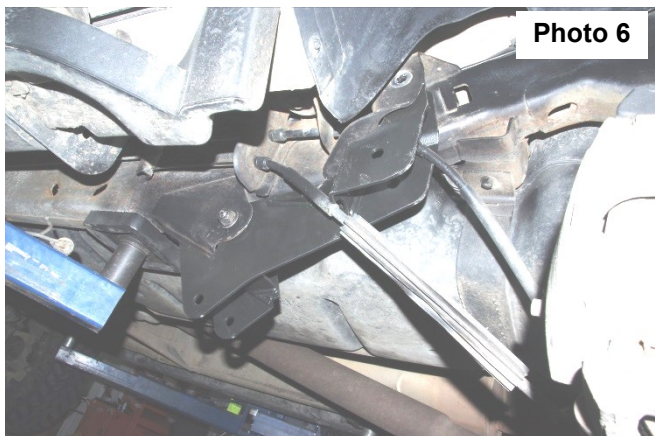

14. Use the factory hardware in the upper control arm mount. **Do Not Tighten. See Photo 8.**
15. Install the supplied flag nut from the rear of the lower control arm pocket. **See Photo 9.**

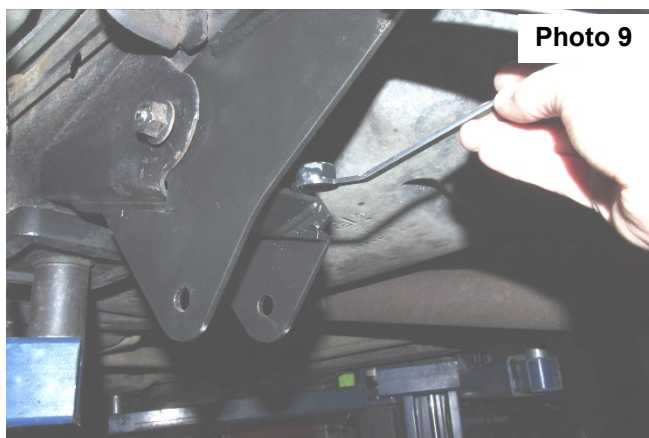

16. Install the supplied 14mm x 40mm bolt, flat washer, and lock washer (1287BAG1) into the flag nut, through the bottom of the control arm drop bracket and the factory lower control arm mount. **Do Not Tighten. See Photo 10.**

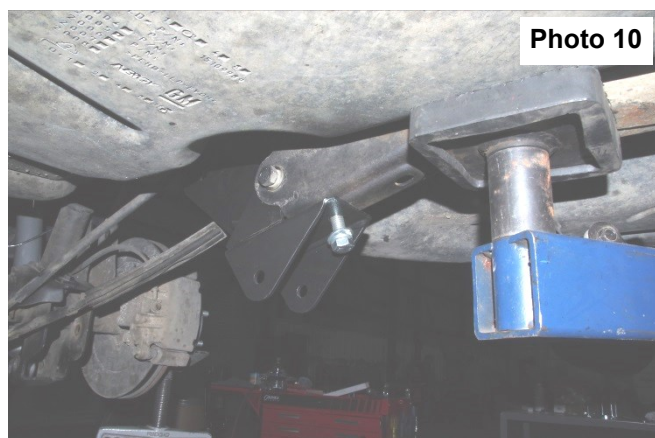

17. Install the upper control arm in the control arm drop bracket using the supplied 9/16" x 4" bolt, washers, and nut (1287BAG1) and on the axle using the factory hardware. **Do Not Tighten. See Photo 11.**
18. Install the lower control arm in the control arm drop bracket using the supplied 9/16" x 4.5" bolt, washers, and nut (1287BAG1) and on the axle using the factory hardware and. **Do Not Tighten. See Photo 12.**

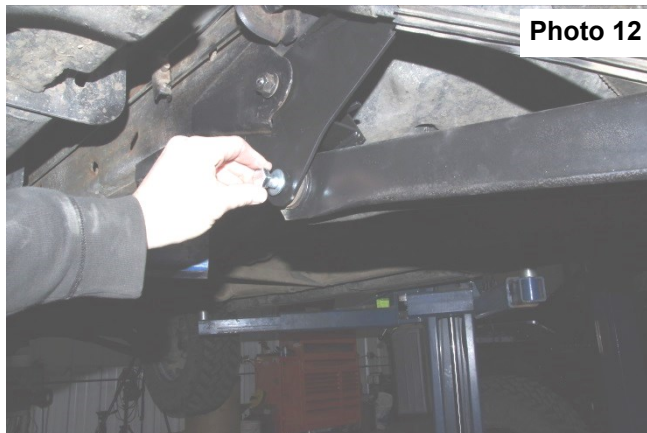
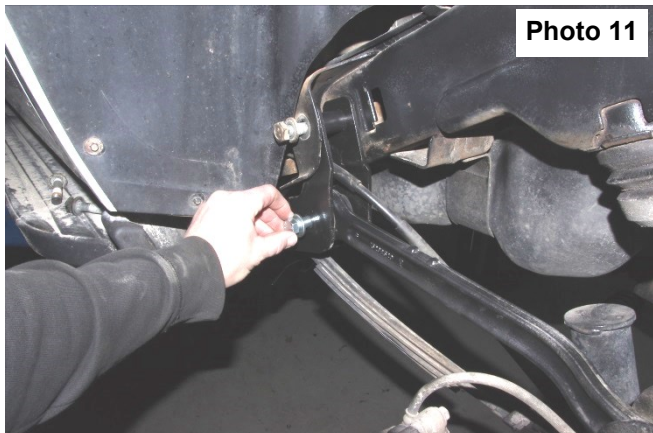

19. Tighten the lower control arm drop bracket bolt using a 21mm socket. Torque to 85 ft-lbs. **See Photo 13.**
20. Tighten the factory control arm hardware using a 21mm. Torque to 95 ft-lbs. **See Photo 14.**

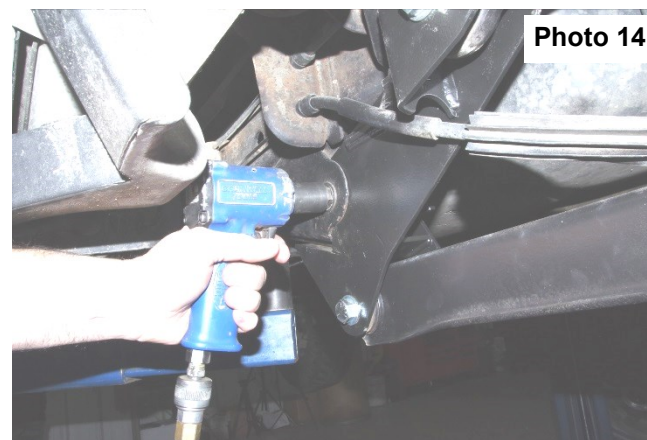
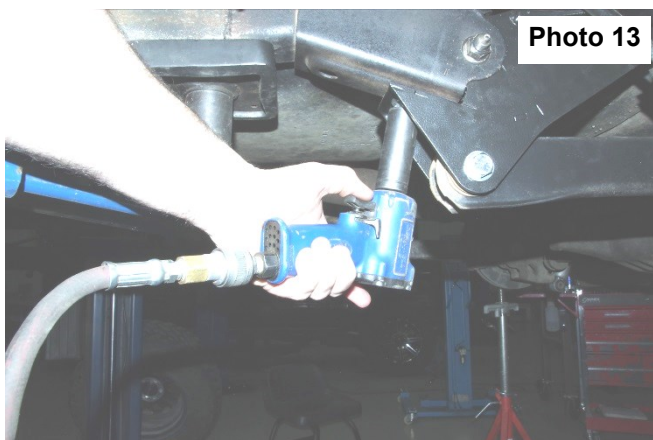

21. Tighten the new 9/16" hardware using a 13/16" socket. Torque to 95 ft-lbs. **See Photo 15.**

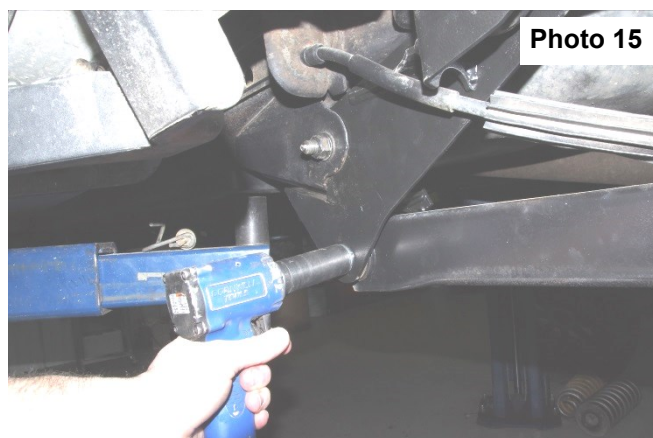

22. Install the supplied coil springs (9404) in the stock location.
23. Install the new track bar bracket as shown in **Photo 16** in the stock location with the supplied crush sleeve and stock hardware with flanged nut towards middle of vehicle. Do not tighten at this time.
24. Make sure the bracket is square as shown in **Photo 17**. Mark and drill the two holes using a 15/32" drill bit. 2017-18 models will use the lower hole.

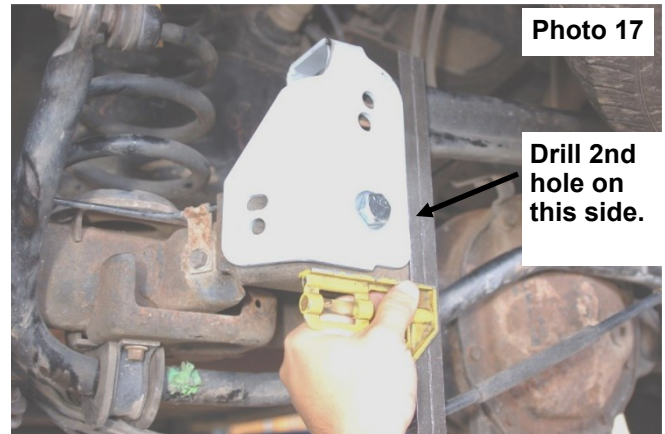
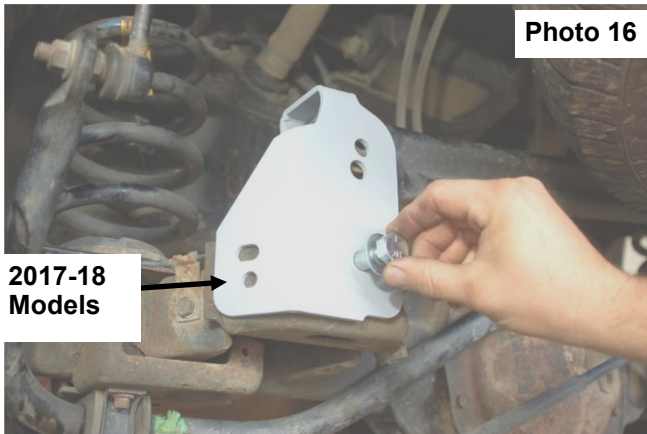

25. Secure with the supplied 7/16" x 1" bolts, washers /nuts as shown in **Photo 18**. Raise the axle to align the track rod with the new bracket and install using supplied 9/16" x 3 1/2" bolt, washers, and nut into the top hole of the track bar bracket. Tighten using a 21mm socket & 22mm wrench. Tighten 7/16" bolts to 52 ft. lbs and the 9/16" bolt to 82 ft. lbs.
26. Install the lower shock relocation bracket (**Please note there is a passenger and driver side bracket**) in the stock location as shown in **Photo 19** using the 1/2" X 1 1/4" bolts, washers & nuts in the lower rear hole and the supplied 9/16" x 3 1/2" bolts, washers, and nuts in the stock location. Tighten 1/2" bolt to 57 ft-lbs. and the 9/16" bolt to 82 ft-lbs.



- The stock shocks will be installed after the vehicle is lowered to the ground using stock hardware.
27. Install the bump stops as shown aligning the new bump stop bracket with the factory bump stop. Mark and drill the holes using a 11/32" drill bit as shown in **Photo 20**.
 28. Install the bump stops with the supplied 3/8" x 1" self tapping bolts using a 9/16" socket. Do not over-tighten. See **Photo 21**.

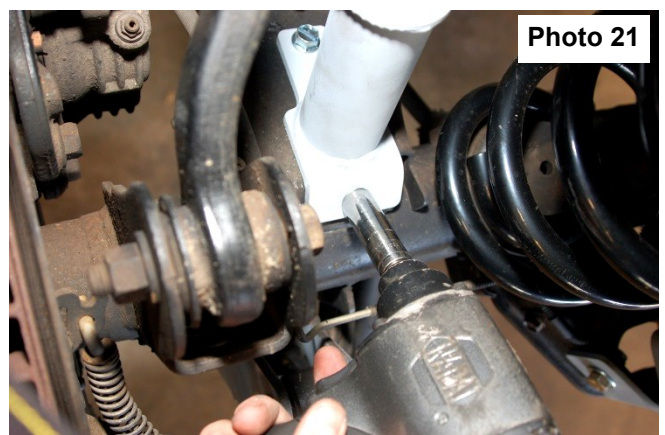
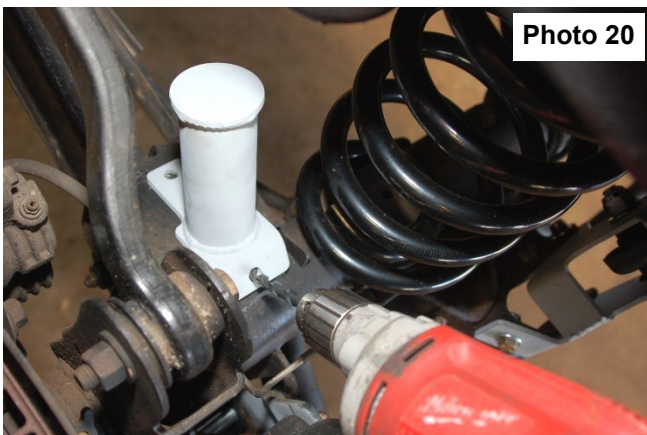

29. Remove the brake line from the brake line bracket using a 1/2" wrench. **See Photo 22.**
30. Install the new brake line bracket as shown in the stock location on the differential with stock hardware using a 13mm wrench. **See Photo 23.** Torque to 15 ft-lbs.

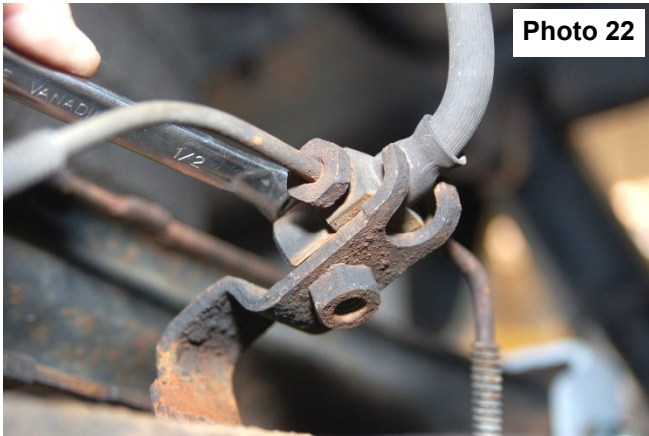

Photo 22

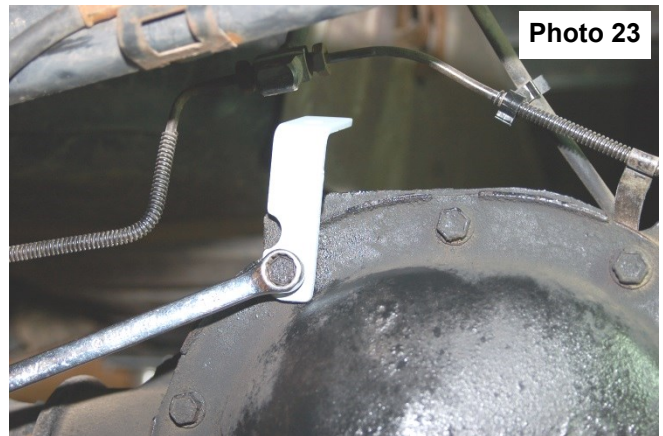

Photo 23

31. Install the brake line on the new brake line extension bracket as shown in **Photo 24** with supplied 5/16" x 1 1/4" bolt, washer & nut. Torque to 15 ft-lbs.
32. Swing the sway bar up and install the supplied rear links as shown in **Photo 25** with supplied 1/2" x 2 1/2" bolts/washers & nuts in lower mount and stock hardware in upper mounts. Tighten to 57 ft. lbs.

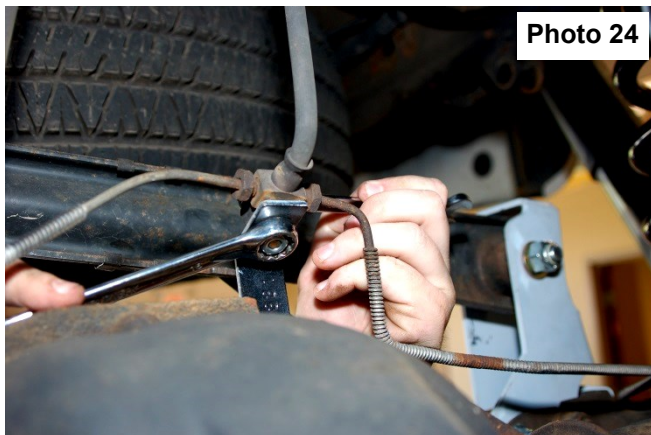

Photo 24

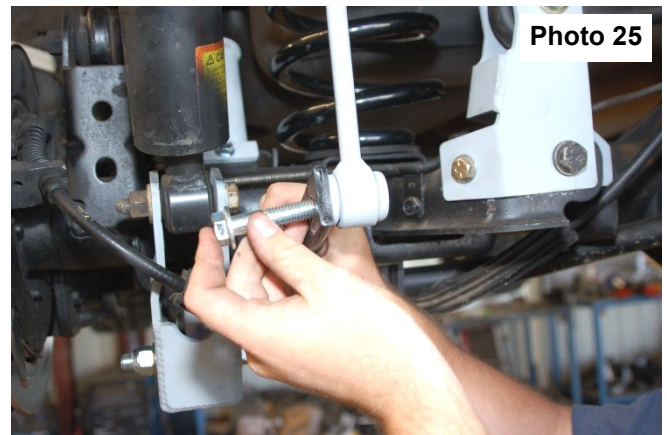

Photo 25

33. If installing on a vehicle with Magna Ride and/or Auto Leveling, remove the factory ride links. Adjust the supplied links to 8" center to center and install in place of the factory link.
34. Install the wheels and tires.
35. Jack up the vehicle and remove the jack stands. Lower the vehicle to the ground.
36. Install the stock shocks in the new mounts with the stock hardware using a 21mm wrench. Tighten to factory specifications.

BUMPSTOP MODIFICATION

1. Remove the bump stop from the stock location on the frame. Trim the bump stop as shown in **Photo 26** using a reciprocating saw. This bump stop modification is only on certain models with 4 ring bump stops.
2. Only the top portion will be trimmed as shown in **Photo 27**. After the bump stop has been trimmed, reinstall on the vehicle in the stock location.

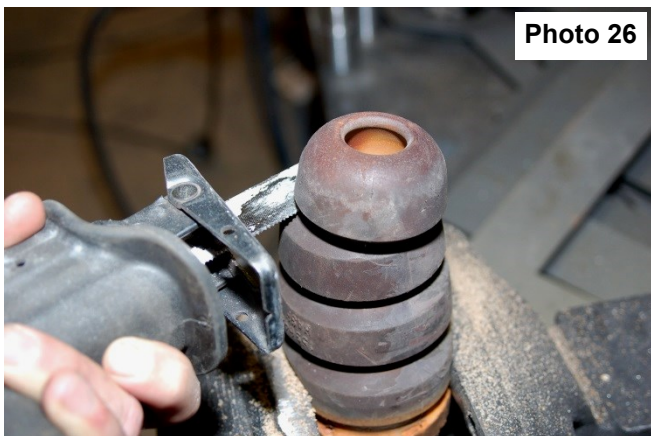

Photo 26



Photo 27

POST INSTALLATION INSTRUCTIONS

1. Check all fasteners for proper torque. Check to ensure for adequate clearance between all rotating, mobile, fixed, and heated members. Verify clearance between exhaust and brake lines, fuel lines, fuel tank, floor boards and wiring harness. Check steering gear for clearance. Test and inspect brake system.
2. Perform steering sweep to ensure front brake hoses have adequate slack and do not contact any rotating, mobile or heated members. Inspect rear brake hoses at full extension for adequate slack. Failure to perform hose check/ replacement may result in component failure.
3. On some vehicles the front lower skirting will need to be trimmed if using certain wheel /tire combinations and with heavy offset wheels. Trim only as needed.
4. Activate four wheel drive system and check front hubs for engagement.
5. Have a qualified alignment center align the vehicle immediately. Realign to factory specifications. The following are the recommended specifications:

Caster in degrees	4.5 +/-1.0
Camber in degrees	0.0—.3
Toe In in degrees	0.1 +/-2
6. Perform head light check and adjustment to proper settings.
7. Check and retighten wheels at 50 miles and again at 500 miles.
8. All kit components must be retightened at 500 miles and then every three thousand miles after installation. Periodically check all hardware for tightness.
9. Install "Warning to Driver" decal on sun visor

Note: Installation of larger tires will require speedometer recalibration.

Thank you for choosing Rough Country for all of your suspension needs.

By purchasing any item sold by Rough Country, LLC, the buyer expressly warrants that he/she is in compliance with all applicable , State, and Local laws and regulations regarding the purchase, ownership, and use of the item. It shall be the buyers responsibility to comply with all Federal, State and Local laws governing the sales of any items listed, illustrated or sold. The buyer expressly agrees to indemnify and hold harmless Rough Country, LLC for all claims resulting directly or indirectly from the purchase, ownership, or use of the items.

