

ROUGH COUNTRY

SUSPENSION SYSTEMS®

92FF318201

FORD 2015-20 F-150 Fender Flare

Thank you for choosing Rough Country for all your vehicle needs.

Please read instructions before beginning installation. Check the kit hardware against the kit contents shown below. Be sure you have all needed parts and know where they go.

If question exist, please call us @1-800-222-7023. We will be happy to answer any questions concerning this product. Check all fasteners for proper torque. Check to ensure for adequate clearance between all components. Periodically check all hardware for tightness.

KIT CONTENTS:
 Front Bracket x4
 Rear Brackets x6

TOOLS NEEDED:
 5.5mm Wrench
 4mm Allen Wrench
 Auto Pry Tool

HARDWARE INCLUDED:
 6mm Button Head Bolts x16
 6mm Flat Washers x18
 6mm Body Clip Nuts x18
 Long Rear Clips x6
 Fender Lip Gasket x6
 Clip Screws x6

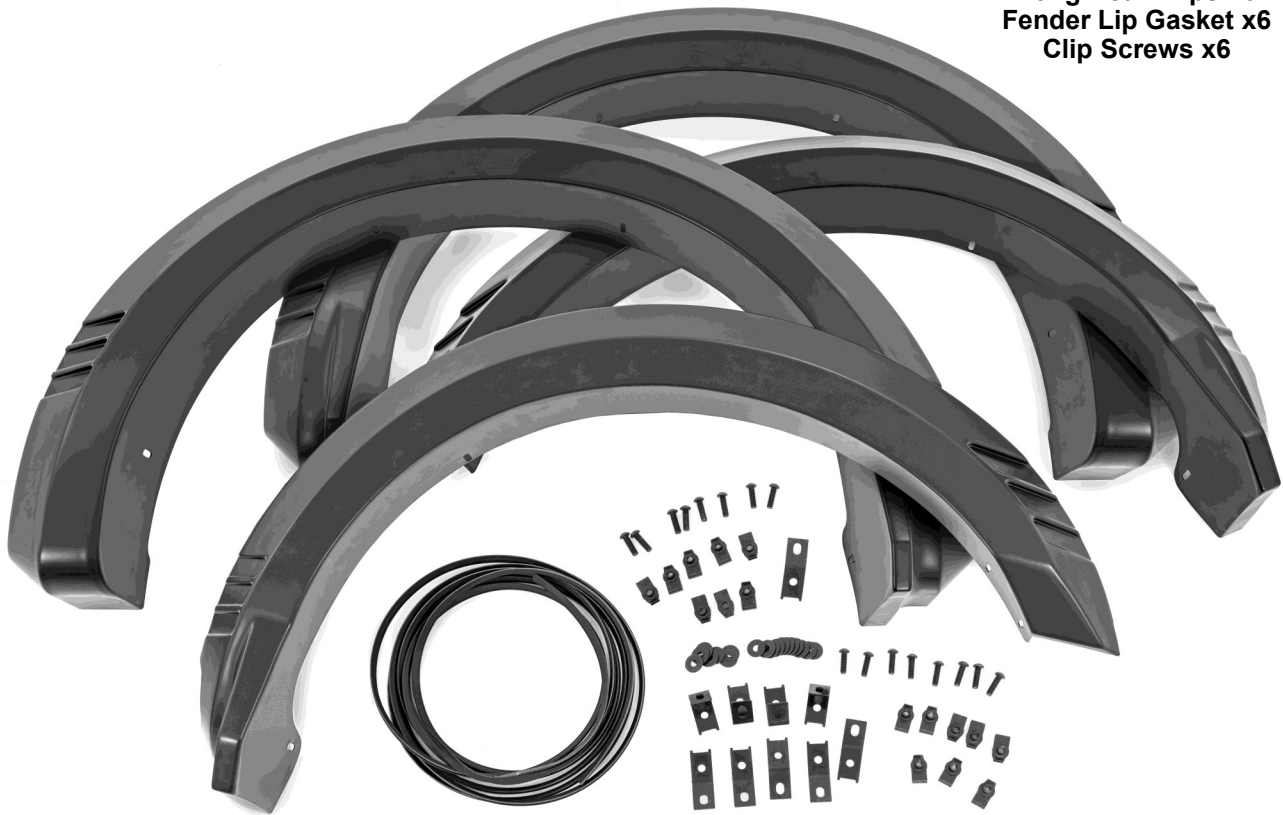

Torque Specs:

Size	Grade 5	Grade 8	Size	Class 8.8	Class 10.9
5/16"	15 ft/lbs	20ft/lbs	6MM	5ft/lbs	9ft/lbs
3/8"	30 ft/lbs	35ft/lbs	8MM	18ft/lbs	23ft/lbs
7/16"	45 ft/lbs	60ft/lbs	10MM	32ft/lbs	45ft/lbs
1/2"	65 ft/lbs	90ft/lbs	12MM	55ft/lbs	75ft/lbs
9/16"	95 ft/lbs	130ft/lbs	14MM	85ft/lbs	120ft/lbs
5/8"	135ft/lbs	175ft/lbs	16MM	130ft/lbs	165ft/lbs
3/4"	185ft/lbs	280ft/lbs	18MM	170ft/lbs	240ft/lbs



FRONT INSTALLATION INSTRUCTIONS

1. Clean any dirt or debris from the outer and inner fender. **See Photo 1.**
2. Locate the (2) fender flare bolts and remove using a 8mm socket. **See Photo 2.**

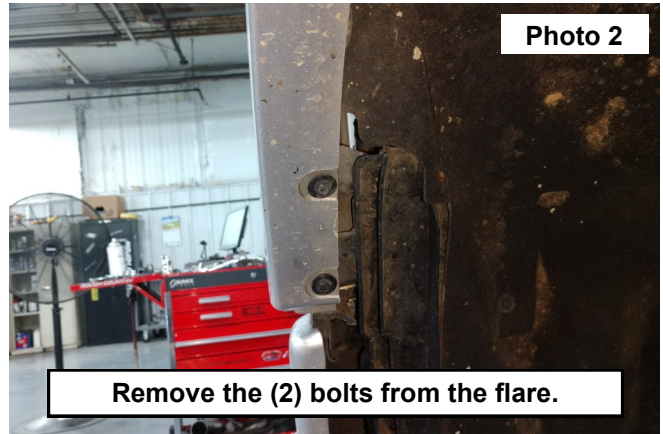

3. Remove the plastic clips from the fender flare using an trim removal tool. **See Photo 3.**
4. Release the inner fender flare clips and remove the fender flare from the vehicle. **See Photo 4.**

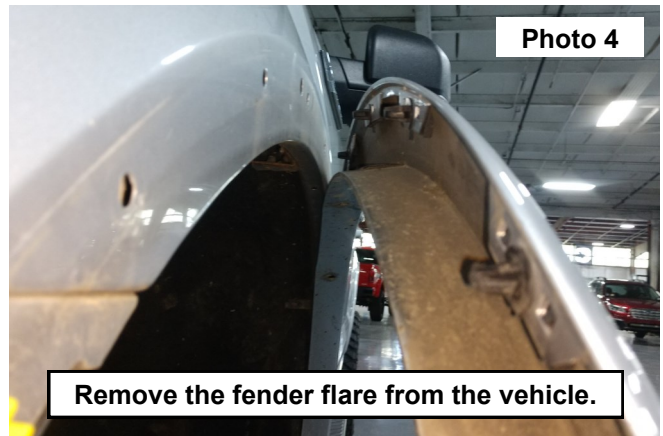

5. Remove any remaining clips from the fender. Arrows show bolts to be removed in step 6. **See Photo 5.**
6. Remove the (2) upper bolts from the inner fender well using a 5.5mm wrench. Retain for later use. **See Photo 6.**

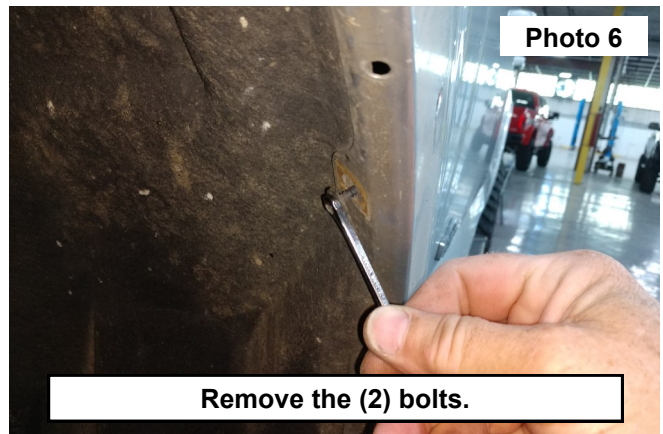
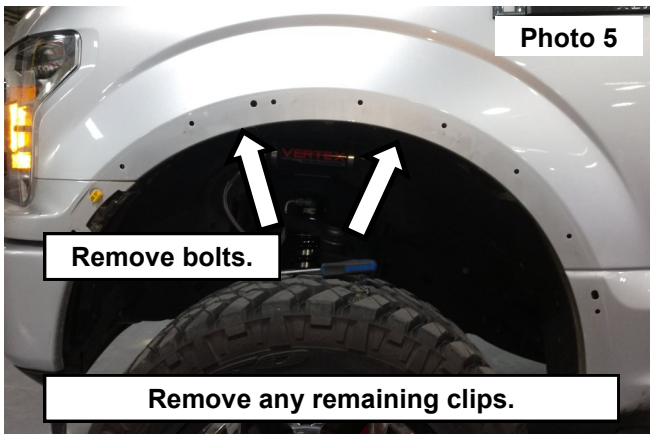

7. Locate the (2) upper fender flair brackets. **See Photo 7.**
8. Install the bracket using the retained bolts from the upper inner fender well using a 5.5mm wrench. **See Photo 8.**

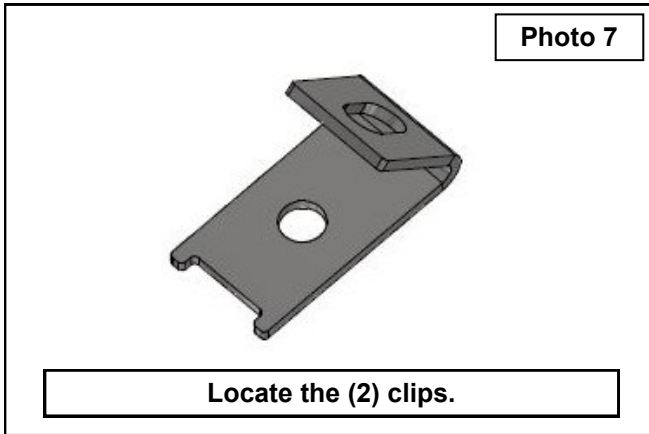

9. Install the (2) 6mm clips with the threaded side to the top on the brackets. **See Photo 9.**
10. Remove the lower fender trim bolt using a 5.5mm wrench. Retain hardware. **See Photo 10.**

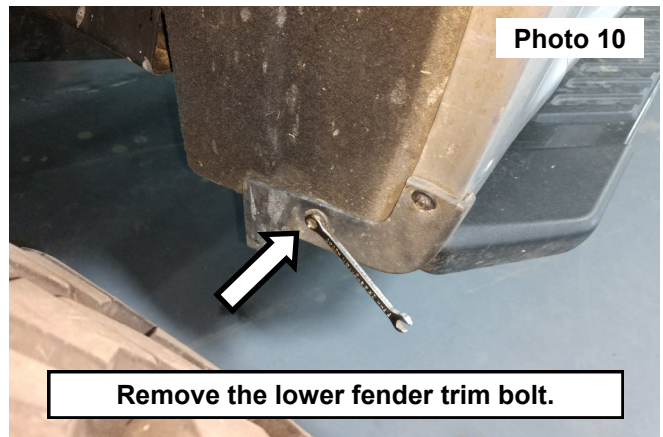
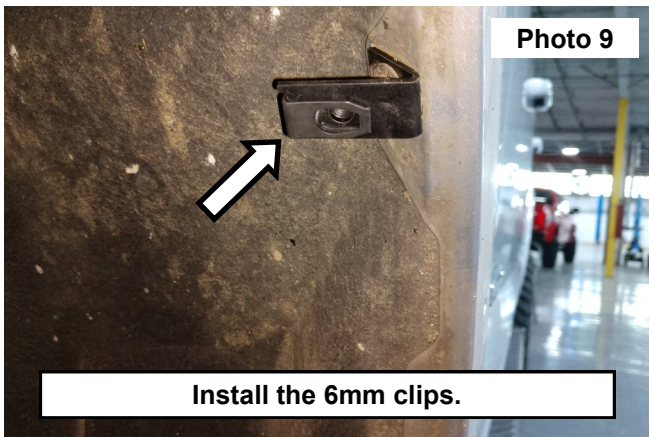

11. Clean the inside edge of the fender flare where the trim will be applied using alcohol pad. Then apply the edge trim around the fender flare and remove the tape covering while pressing the trim into place. **See Photo 11.**
12. Trim the excess of the fender trim from the fender flare. **See Photo 12.**

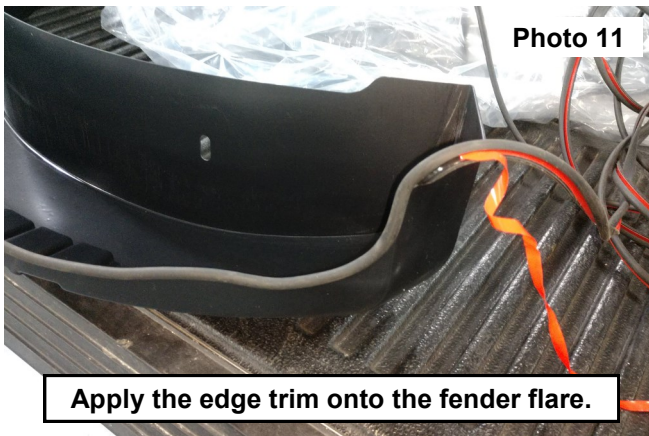

13. Place the fender flare onto to the vehicle. **See Photo 13.**

14. Secure the front of the fender flare using the (2) OE bolts. Tighten using a 5.5mm socket. **See Photo 14.**

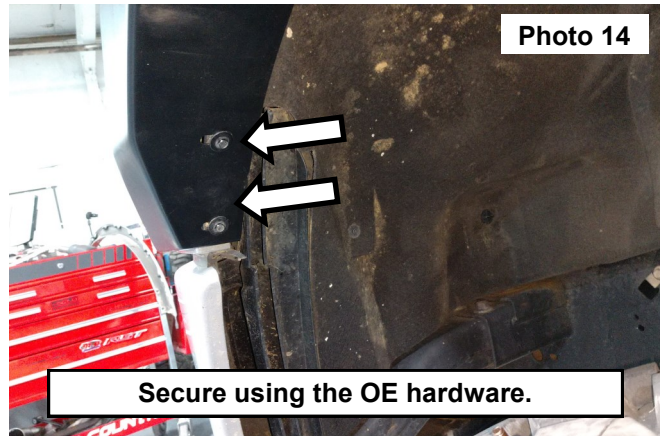

15. Install (2) of the supplied 6mm button head bolts and (2) 6mm flat washers into the installed brackets and clips at the top of the fender. Tighten using a 4mm allen wrench. **See Photos 15 and 16.**

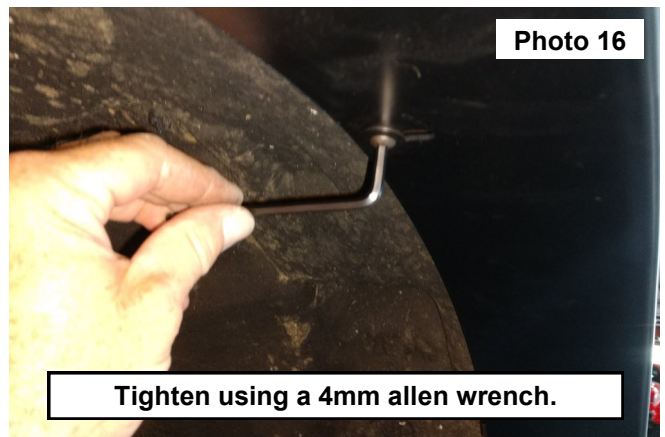
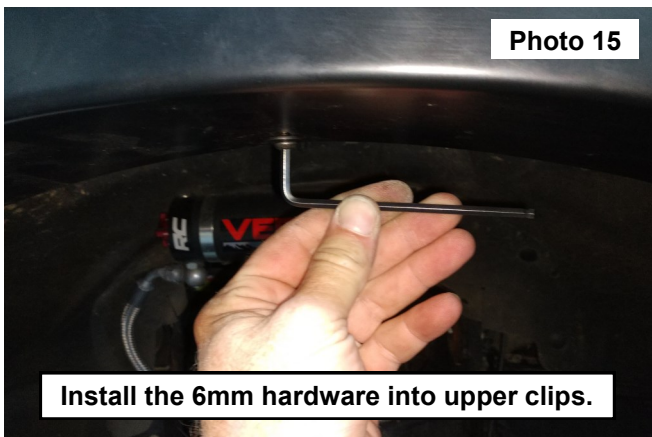

16. Secure the lower fender flare using the retained OE bolt . Tighten using a 5.5mm wrench. **See Photo 17.**

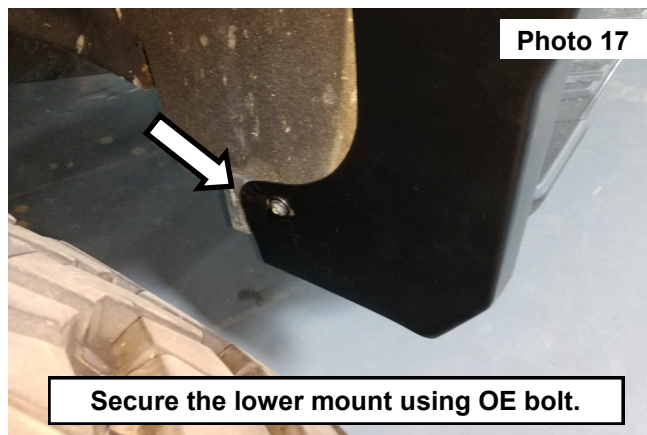

REAR INSTALLATION INSTRUCTONS

1. On the 18-20 Models the truck could be equipped with a factory trim flare. If so please proceed to the next steps. If not factory equipped, please skip to **Step 19**.
2. Locate the (4) push pins in the OE fender flare. **See Photo 1**.
3. Use an auto pry tool to remove the push pins. **See Photo 2**.

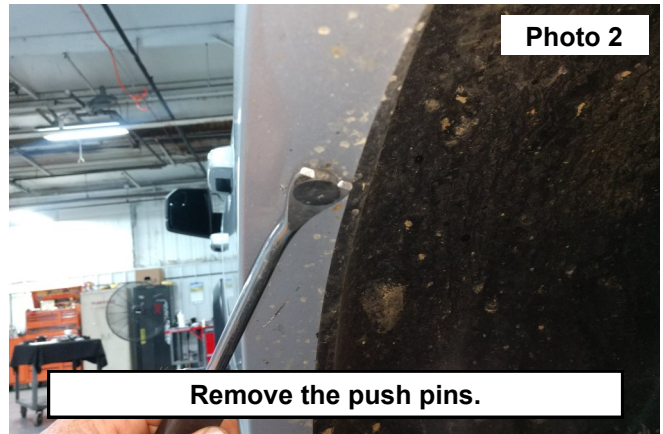

4. Locate the bolts at the bottom of the fender flare on each side of the fender well. **See Photo 3**.
5. Remove the bolts in the lower fender flare using a 10mm socket. **See Photos 4 and 5**.

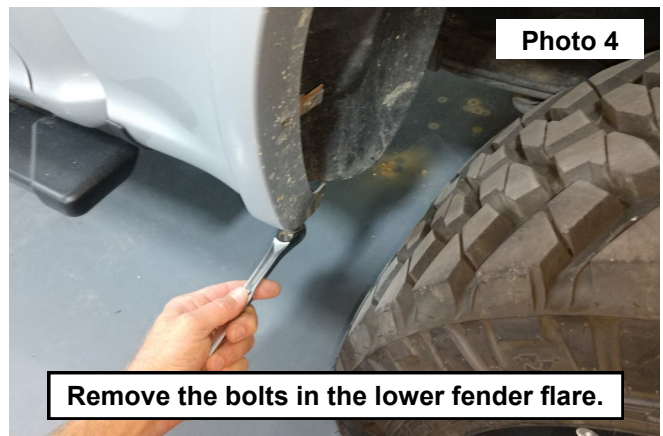

6. Starting at the bottom of the flare. Remove the flare and clips from the bed side. **See Photo 6**.

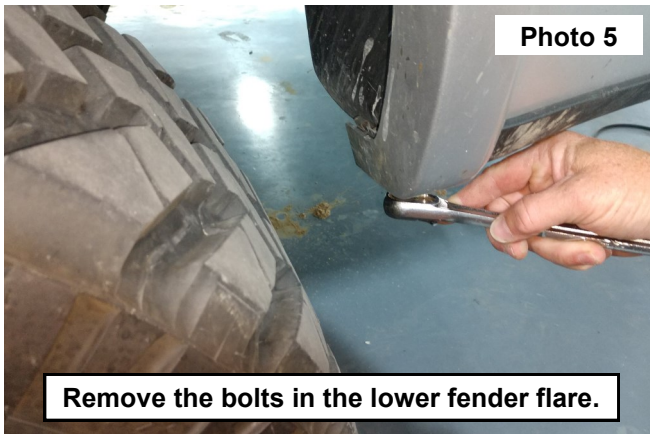

7. Clean any dirt or debris from the bed side. **See Photo 7.**
8. Install the clips onto the rear brackets. **NOTE:** The threads of the clip are to the bend line side of the bracket. **See Photo 8.**

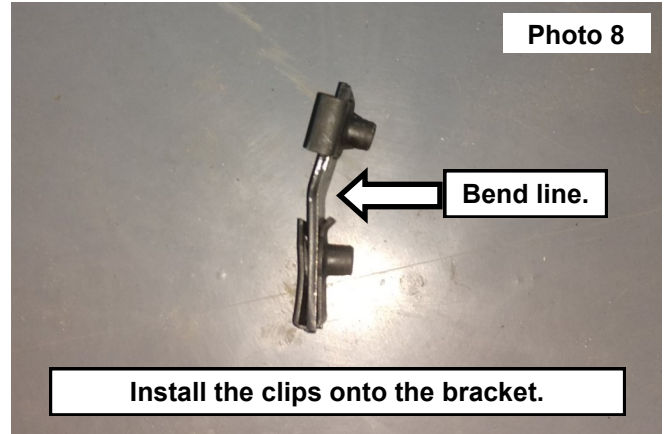

9. Install the (2) brackets onto the top of the fender well. Secure Using the supplied 6mm button head bolts and 6mm washers. Tighten using a 4mm allen wrench. **See Photos 9 and 10.**

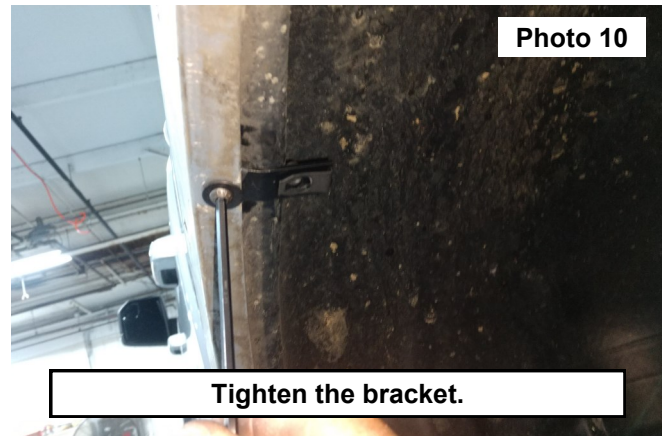
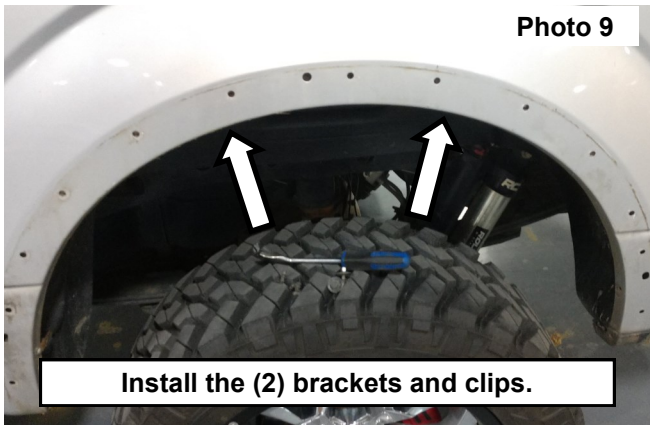

10. Install one of the 6mm clips at the front lower push pin holes. **See Photo 11.**
11. Remove the rear lower push pin from the splash guard using a trim removal tool. **See Photo 12.**

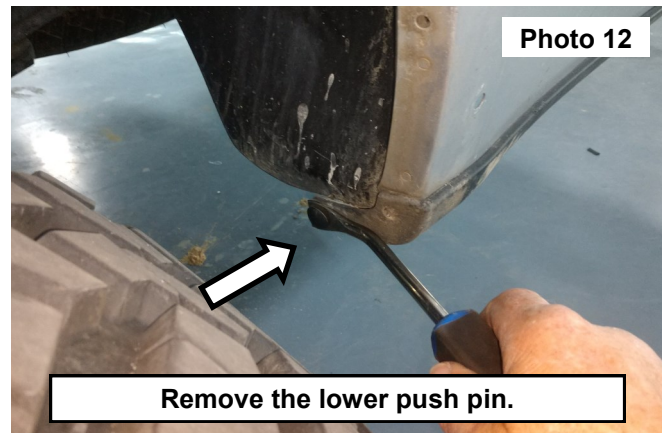
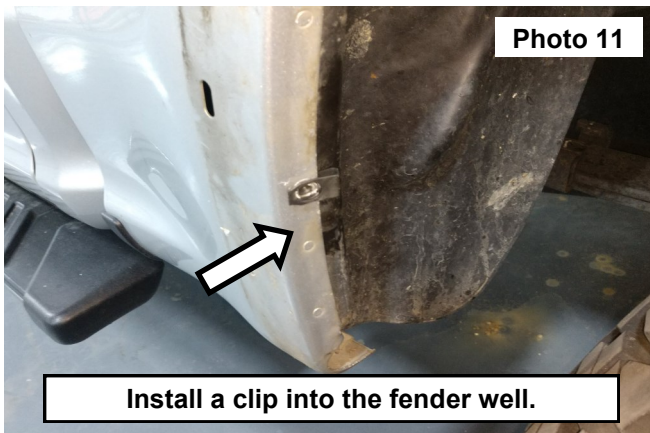

12. Install a 6mm clip onto the push pin hole. The front of the clip will go in-between the splash guard and the bed. **See Photo 13.**
13. Clean the inside edge of the fender flare where the trim will be applied using alcohol pad. Then apply the edge trim around the fender flare and remove the tape covering while pressing the trim into place. **See Photo 14.**

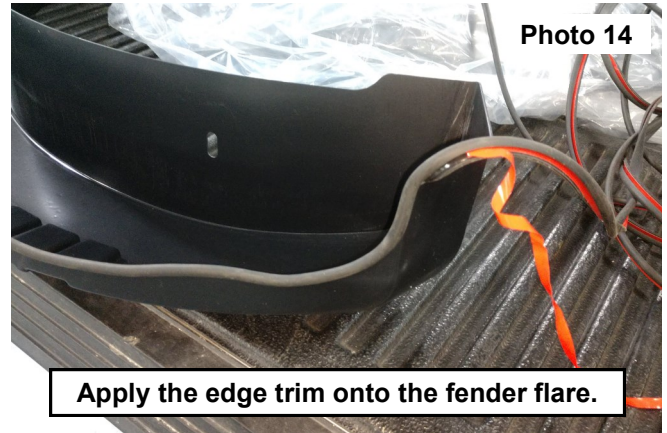
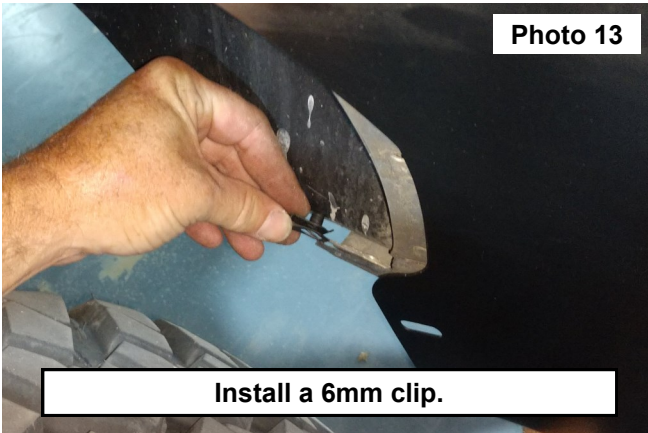

14. Trim the excess of the fender trim from the fender flare. **See Photo 15.**
15. Install the fender flare onto the bed side and secure using the (4) supplied 6mm button head bolts and (4) flat washers. **See Photo 16.**

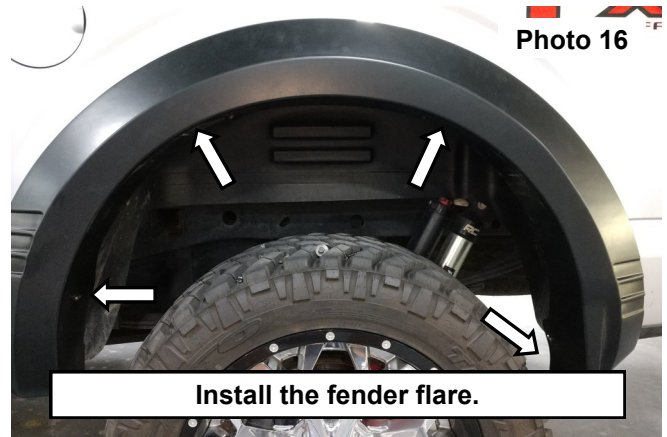

16. Install the 6mm bolts and flat washers into the threaded side of the (4) clips.
17. Adjust the fender flare to the desired look and tighten using a 4mm allen wrench. **See Photo 17 and 18.**
18. Repeat steps 1-16 on the opposite side of the vehicle.

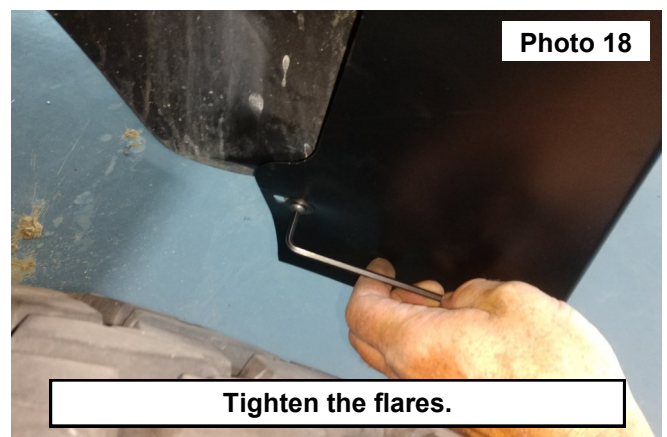
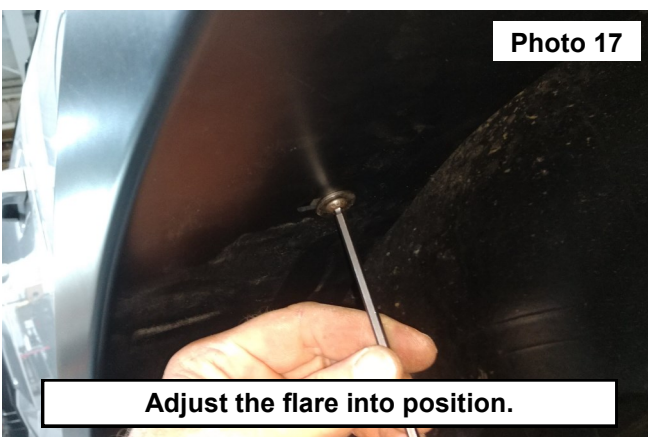

19. If not factory equipped with trim flare, position the rear flare noting the location of the clips to be installed. **See Photo 20.**
20. Remove the flare and place the supplied long body clips into position with the protective rubber gasket between the clips and the fender lips 3 clips per flare. **See Photo 21.**

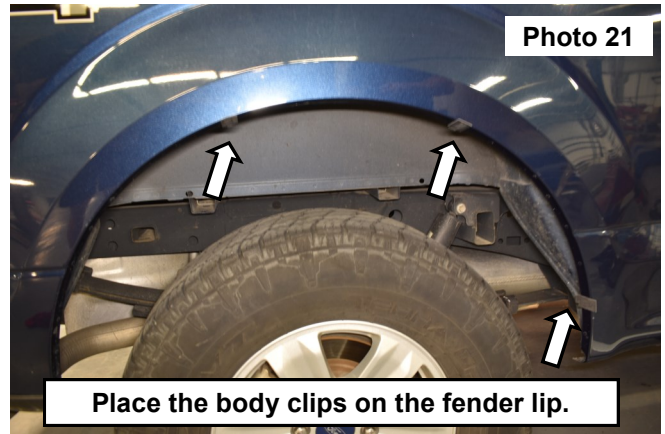
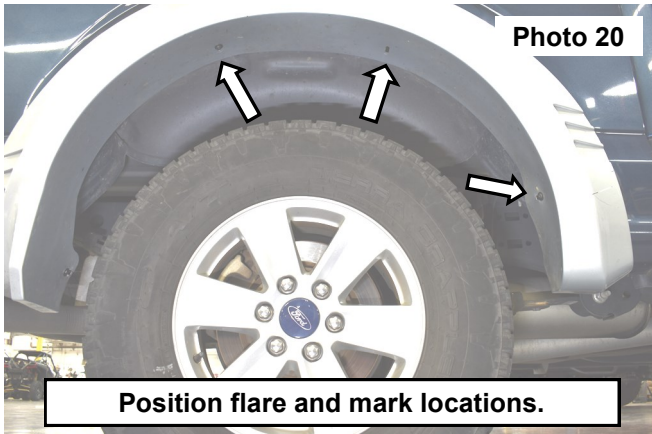

21. Place the supplied threaded clip and install the supplied screw in the rear of the flare. **See photo 22 & 23.**

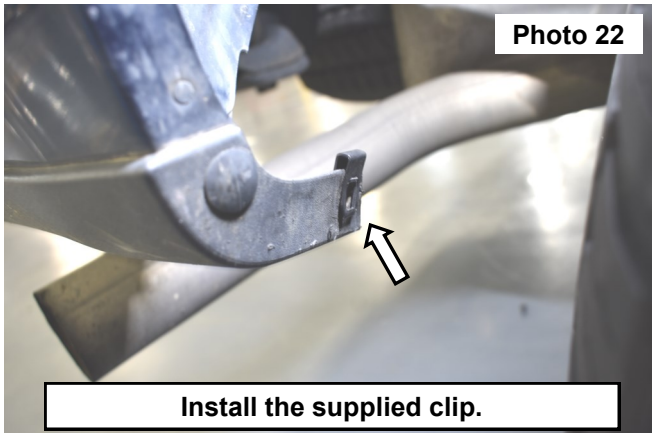

22. Apply slight pressure to the flare to ensure that it is tight against the body and secure using the supplied screws and washers. Tighten hardware. **See Photo 24 & 25.**

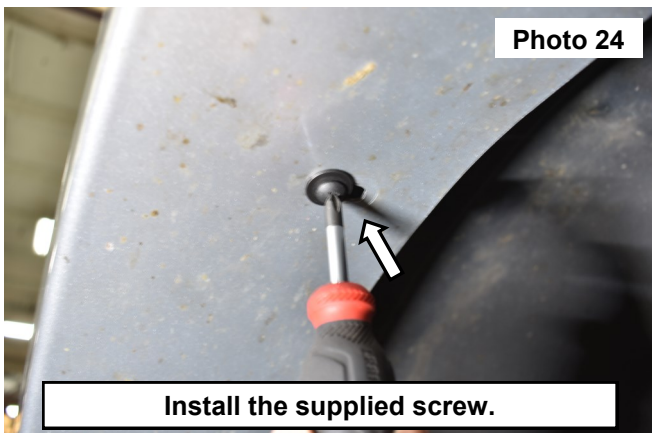



By purchasing any item sold by Rough Country, LLC, the buyer expressly warrants that he/she is in compliance with all applicable, State, and Local laws and regulations regarding the purchase, ownership, and use of the item. It shall be the buyers responsibility to comply with all Federal, State and Local laws governing the sales of any items listed, illustrated or sold. The buyer expressly agrees to indemnify and hold harmless Rough Country, LLC for all claims resulting directly or indirectly from the purchase, ownership, or use of the items.

